



iO-GRID™

Digital Output Module

User's Manual



Table of Contents

1.	Digital Output Module List	3
	Product Description	3
2.	Digital Output Module Specification	5
2.1	GFDO-RM01N	5
2.1	GFDO-RM02N	6
3.	Digital Output Module Information	7
3.1	Digital Output Module Dimension	7
3.2	Digital Output Module Panel Information	8
3.2	Digital Output Module Wiring Diagram	10
4.	Module Installation/Disassembly	11
4.1	Installation	11
4.2	Removal	12
5.	iO-GRID[™] Series Introduction	13
5.1	iO-GRID[™] Components	13
6.	I/O Module Parameter Settings and Introduction	16
6.1	I/O Module Settings and Connections	16
7.	Digital Output Module Control Register Description	22
7.1	Digital Output Module Register Communication Method	22
7.2	Digital Output Module Register Format Information (0x2000, rewritable)	24
7.3	Modbus function code 0x10 Demonstration	24
7.4	Supports Modbus function code	25

1. Digital Output Module List

Product No.	Description	Remarks
GFDO-RM01N	16-channel digital output module (sink, 24VDC, 0138 terminal block)	
GFDO-RM02N	16-channel digital output module (source, 24VDC, 0138 terminal block)	

Product Description

GFDO, digital output module series is specially designed for industrial applications. It's the open-type industrial equipment which is intended for installation within enclosures supplied in the field. A digital output allows you to control a voltage with a controller. If the controller instructs the output to be high, the output will produce a voltage (about 24 volts). If the controller instructs the output to be low, its connected to ground and produces no voltage. And the circuit design & all the components of GFDO series are compliant with the latest requirements and standards of UL, CE & RoHS. It has a complete circuit protection design to resist overload, overvoltage and short circuit etc. It is avoided to damage & failure caused from improper operations.



Caution (ATTENTION):

1. THIS DEVICE IS FOR INDOOR USE ONLY, DON'T PUT OR USE IT IN HIGH TEMPERATURE AND HIGH MOISTURE ENVIRONMENT.
CET EQUIPEMENT EST DESTINE A UN USAGE INTERIEUR UNIQUEMENT NE PAS STOCKER OU UTILISER DANS UN ENVIRONNEMENT A HAUTE TEMPERATURE ET HAUTE HUMIDITE.
2. AVOID FALLING AND BUMPING OTHERWISE THE ELECTRICAL COMPONENTS WILL BE DAMAGED.
ÉVITEZ DE TOMBER ET DE VOUS ÉCRASER, SINON LES COMPOSANTS ÉLECTRIQUES SERONT ENDOMMAGÉS
3. DON'T TRY TO DISASSEMBLE OR OPEN THE COVER UNDER ANY CIRCUMSTANCE IN ORDER TO AVOID DANGER.
NE TENTEZ JAMAIS DE DEBALLER OU D'OUVRIR LE COUVERCLE POUR EVITER TOUT DANGER.
4. IF THE EQUIPMENT IS USED IN A MANNER NOT SPECIFIED BY THE MANUFACTURER, THE PROTECTION PROVIDED BY THE EQUIPMENT MAY BE IMPAIRED.
SI L'APPAREIL N'EST PAS UTILISE DE LA MANIERE INDIQUEE PAR LE FABRICANT, LA PROTECTION FOURNIE PAR L'APPAREIL PEUT ETRE ALTEREE.
5. THE INSTALLATION THAT THE SAFETY OF ANY SYSTEM INCORPORATING THE EQUIPMENT IS THE RESPONSIBILITY OF THE ASSEMBLER OF THE SYSTEM.
L'INSTALLATION DE TOUT SYSTÈME INTÉGRANT CET ÉQUIPEMENT EST LA RESPONSABILITÉ DU CONSTRUCTEUR DU SYSTÈME.
6. USE WITH COPPER CONDUCTORS ONLY. INPUT WIRING: MINIMUM 28 AWG, 85°C, OUTPUT WIRING: MINIMUM 28 AWG, 85°C
DESTINÉ À ÊTRE UTILISÉ AVEC DES CONDUCTEURS EN CUIVRE SEULEMENT. CABLAGE D'ENTREE: MINIMUM 24 AWG, 85 ° C. CABLAGE DE SORTIE: MINIMUM 28 AWG, 85 ° C.
7. FOR USE IN A CONTROLLED ENVIRONMENT. REFER TO MANUAL FOR ENVIRONMENTAL CONDITIONS.
POUR UN ENVIRONNEMENT CONTROLE. REPORTEZ-VOUS AU MANUEL DES CONDITIONS ENVIRONNEMENTALES.
8. DISCONNECT ALL SOURCES OF SUPPLY BEFORE SERVICING.
COUPER TOUTES LES SOURCES D'ALIMENTATION AVANT DE FAIRE L'ENTRETIEN ET LES RÉPARATIONS.
9. PROPER VENTILATION IS REQUIRED TO REDUCE THE RISK OF HAZARDOUS OR EXPLOSIVE GAS BUILDUP DURING INDOOR CHARGING. SEE OWNERS MANUAL.
UNE VENTILATION ADÉQUATE EST NÉCESSAIRE AFIN DE RÉDUIRE LES RISQUES D'ACCUMULATION DE GAZ DANGEREUX OU EXPLOSIFS DURANT LA RECHARGE À L'INTÉRIEUR. VOIR LE MANUEL D'ENTRETIEN.

2. Digital Output Module Specification



2.1 GFDO-RM01N

Technical Specification	
Number Of Outputs	16
Load Voltage	24 VDC (±10%)
Voltage Supply	5 VDC via Dinkle Bus
Current Consumption	135 mA @ 5 VDC
Load Type	Resistive Load, Nominal Load
Connection Type	Sink
Output Current Per Channel For Signal (Max.)	0.5A
Communication Interface	RS485 via Dinkle Bus
Communication Specification	
Fieldbus Protocol	Modbus RTU
Format	N, 8, 1
Baud Rate Range	1200-1.5 Mbps
General Specification	
Dimension (W*D*H)	12 x 100 x 97mm
Weight	69g
Ambient Temperature (operation)	-10...+60°C
Storage Temperature	-25°C...+85°C
Permissible Humidity(non-condensing)	RH 95%
Altitude Limit	< 2000 m
Ingress Protection (IP)	IP 20
Pollution Severity	II
Safety Approval	CE
Product Certification	UL / CSA / IEC 61010-2-201&-1
Wiring Range (IEC / UL)	0.2 mm ² ~ 1.5 mm ² / AWG 28~16
Wiring Ferrules	DN00510D、DN00710D

2.1 GFDO-RM02N

Technical Specification	
Number Of Outputs	16
Load Voltage	24 VDC (±10%)
Voltage Supply	5 VDC via Dinkle Bus
Current Consumption	135 mA @ 5 VDC
Load Type	Resistive Load, Nominal Load
Connection Type	Source
Output Current Per Channel For Signal (Max.)	0.5A
Communication Interface	RS485 via Dinkle Bus
Communication Specification	
Fieldbus Protocol	Modbus RTU
Format	N, 8, 1
Baud Rate Range	1200-1.5 Mbps
General Specification	
Dimension (W*D*H)	12 x 100 x 97mm
Weight	69g
Ambient Temperature (operation)	-10...+60°C
Storage Temperature	-25°C...+85°C
Permissible Humidity(non-condensing)	RH 95%
Altitude Limit	< 2000 m
Ingress Protection (IP)	IP 20
Pollution Severity	II
Safety Approval	CE
Product Certification	UL / CSA / IEC 61010-2-201&-1
Wiring Range (IEC / UL)	0.2 mm ² ~ 1.5 mm ² / AWG 28~16
Wiring Ferrules	DN00510D、DN00710D

3. Digital Output Module Information



3.1 Digital Output Module Dimension

I. GFDO-RM01N

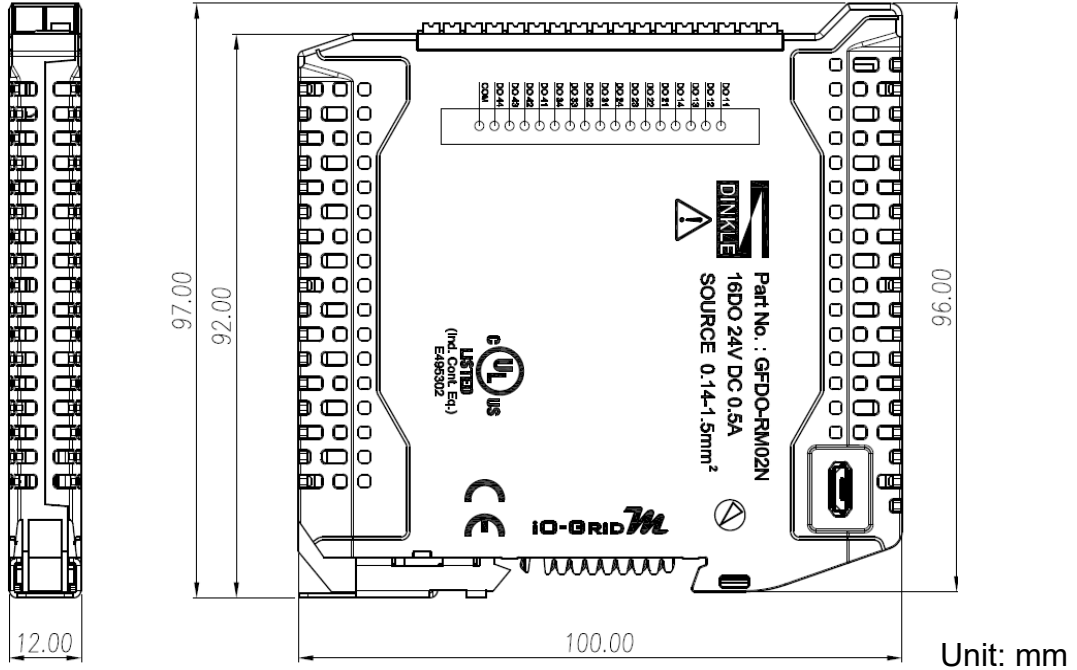

II. GFDO-RM02N

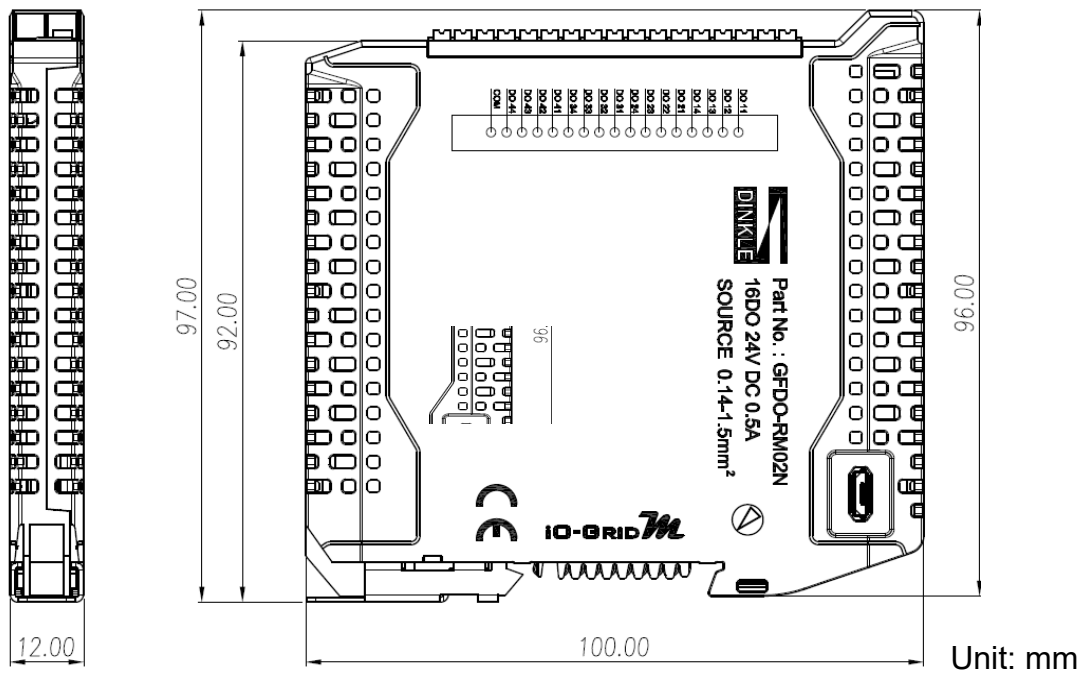

3.2 Digital Output Module Panel Information



I. GFDO-RM01N

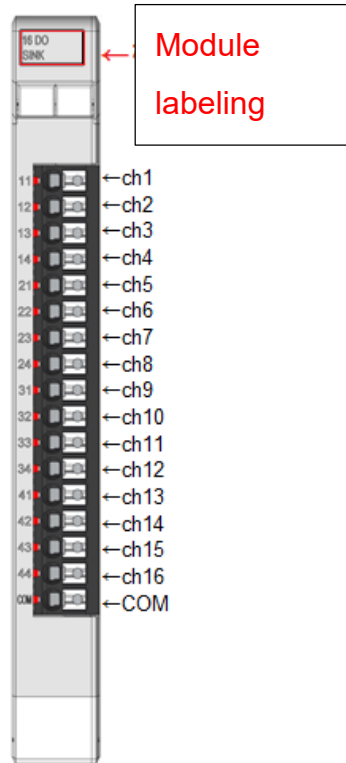

Terminal block connector definitions

Terminal block labeling	Connector definitions	Terminal block labeling	Connector definitions
11	Channel 1	31	Channel 9
12	Channel 2	32	Channel 10
13	Channel 3	33	Channel 11
14	Channel 4	34	Channel 12
21	Channel 5	41	Channel 13
22	Channel 6	42	Channel 14
23	Channel 7	43	Channel 15
24	Channel 8	44	Channel 16
		S/S	Common port

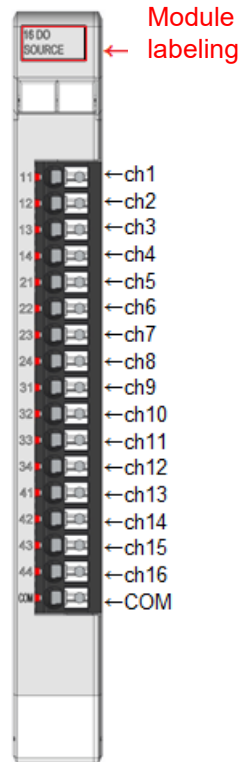
II. GFDO-RM02N

Terminal block connector definitions

Terminal block labeling	Connector definitions	Terminal block labeling	Connector definitions
11	Channel 1	31	Channel 9
12	Channel 2	32	Channel 10
13	Channel 3	33	Channel 11
14	Channel 4	34	Channel 12
21	Channel 5	41	Channel 13
22	Channel 6	42	Channel 14
23	Channel 7	43	Channel 15
24	Channel 8	44	Channel 16
		S/S	Common port

3.2 Digital Output Module Wiring Diagram



I. GFDO-RM01N

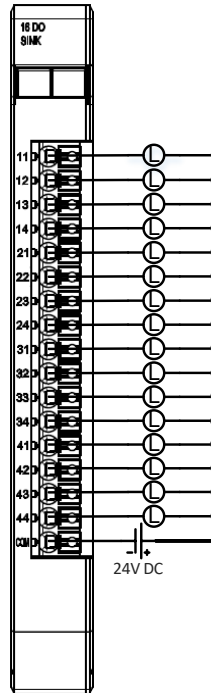

II. GFDO-RM02N

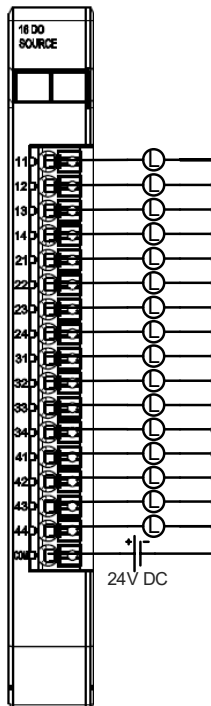

4. Module Installation/Disassembly

4.1 Installation

- I. Align the red arrow on the side of the module to the arrow on the DIN rail.
- II. Press the module down and the metal clamp will slide (thanks to its spring mechanism) and grab on the other side of the DIN rail. Continue to push down until the metal clamp “clicks”.

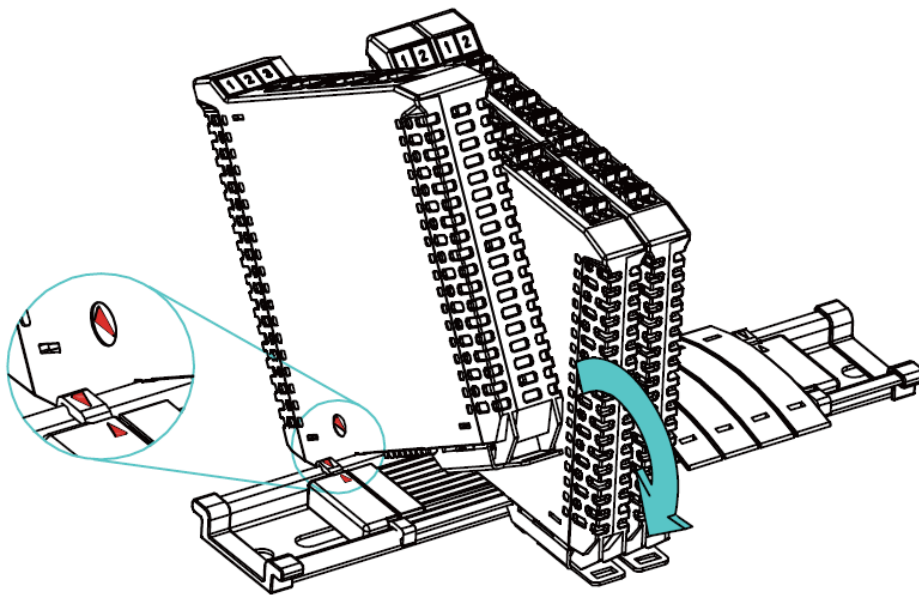

*Note: Make sure the red arrows on the module and the rail are pointing the same direction.

4.2 Removal

- I. Use a screwdriver to pull the metal hook sideways and detach the module from the DIN rail.

- II. Remove all modules from the DIN rail in reverse order of installation.

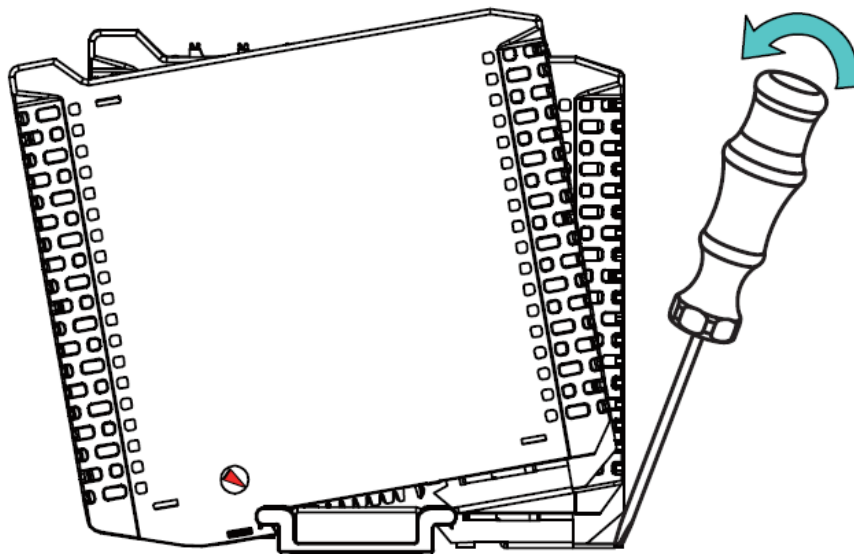

5. iO-GRID™ Series Introduction

iO-GRID™ series utilizes the standard Modbus communication protocol and supports Modbus RTU/ASCII and Modbus TCP. Please choose products and factory controllers to figure your system based on your communication protocol.

5.1 iO-GRID™ Components

I. DINKLE Bus

Rail 1 to 4 are defined for power supply and rail 5 to 7 are defined for communication.

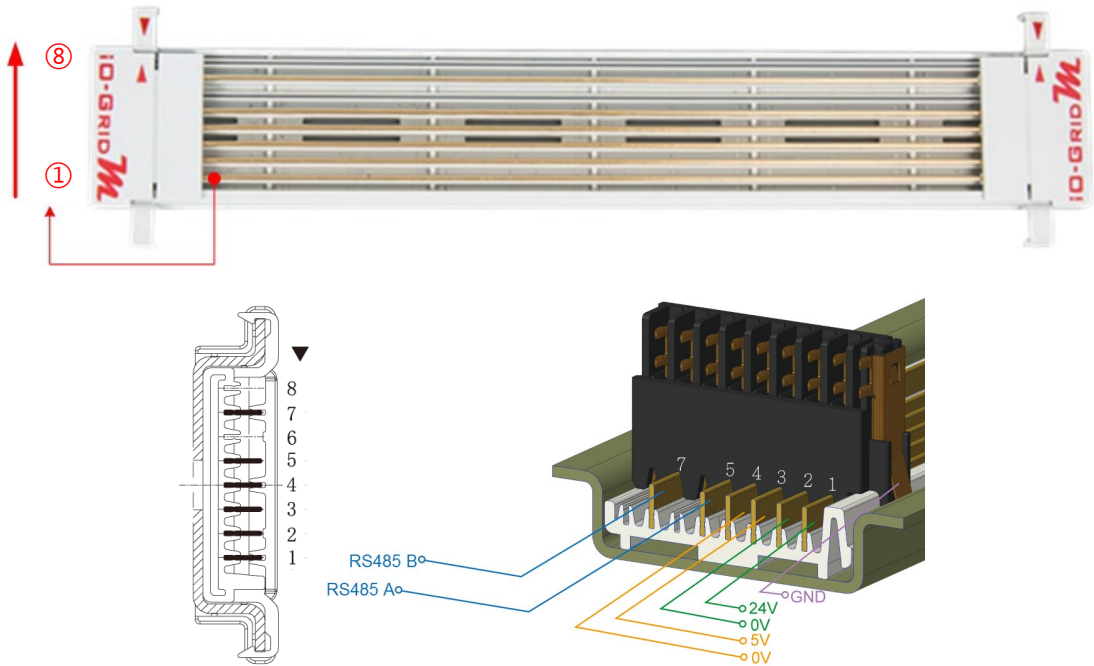

DINKLE Bus Rail Definitions:

Rail	Definition	Rail	Definition
8	—	4	0V
7	RS485B	3	5V
6	—	2	0V
5	RS485A	1	24V

II. Gateway Module

A gateway module converts between Modbus TCP and Modbus RTU/ASCII. The module provides two sets of external Ethernet ports to connect to the controller and the Internet

There are two types of gateway modules available:

4-channel gateway module: Provides 4 RS485 ports to connect to a control module

Single-channel gateway module: No external connectivity for the RS485 ports.

The RS485 signals are transmitted via DINKLE Bus and I/O module.

Gateway module products information:

Product No.	Description
GFGW-RM01N	Modbus TCP-to-Modbus RTU/ASCII gateway module. 4 Ports
GFGW-RM02N	Modbus TCP-to-Modbus RTU/ASCII gateway module. 1 Port

III. Control module

The control module manages I/O modules and sets up the configuration. Provides external RS485 ports to connect to the controller.

There are two types of control modules available:

3-channel control module:

Provides 3 external RS485 ports, suitable stations with 2 or more control modules. Among the RS485 ports, 2 of them will be connected to the controller and the control module of the next station

Single-channel control module:

Provides one single RS485 port to connect to the controller, suitable for single-module stations.

Control module products information:

Product No.	Description
GFMS-RM01N	RS485 control module, Modbus RTU/ASCII 3 Ports
GFMS-RM01S	RS485 control module, Modbus RTU/ASCII 1 Port

IV. I/O Module

Dinkle offers different types of I/O modules with different functions:

Product No.	Description
GFDI-RM01N	16-channel digital input module (source/sink)
GFDO-RM01N	16-channel digital output module (sink)
GFDO-RM02N	16-channel digital output module (Source)
GFAR-RM11	8-Channel relay module, grounded
GFAR-RM21	4-Channel relay module, grounded
GFAI-RM10	4-channel analog input module ($\pm 10\text{VDC}$)
GFAI-RM11	4-channel analog input module (0...10VDC)
GFAI-RM20	4-channel analog input module (0... 20mA)
GFAI-RM21	4-channel analog input module (4... 20mA)
GFAO-RM10	4-channel analog output module ($\pm 10\text{VDC}$)
GFAO-RM11	4-channel analog output module (0...10VDC)
GFAO-RM20	4-channel analog output module (0... 20mA)
GFAO-RM21	4-channel analog output module (4... 20mA)
GFAX-RM10	2-channel analog input module, 2-channel analog output module ($\pm 10\text{VDC}$)
GFAX-RM11	2-channel analog input module, 2-channel analog output module (0...10VDC)
GFAX-RM20	2-channel analog input module, 2-channel analog output module (0... 20mA)
GFAX-RM21	2-channel analog input module, 2-channel analog output module (4... 20mA)

6. I/O Module Parameter Settings and Introduction

6.1 I/O Module Settings and Connections

I. I/O Module System Configuration List

Name/Product No.	Description
GFDO-RM01N	16-channel digital output module (sink)
GFDO-RM02N	16-channel digital output module (Source)
GFTL-RM01	USB-to-RS232 converter
Micro USB cable	Must have data transfer functionality
Computer	USB-compatible

II. Module Initial Setting List

Product No.	Description	Station No.	Baud rate	Format
GFMS-RM01N	RS485 control module, RTU/ASCII	1	115200	RTU(8,N,1)
GFDI-RM01N	16-channel digital input module (source/sink)	1	115200	RTU(8,N,1)
GFDO-RM01N	16-channel digital output module (sink)	1	115200	RTU(8,N,1)
GFDO-RM02N	16-channel digital output module (Source)	1	115200	RTU(8,N,1)
GFAR-RM11	8-Channel relay module, grounded	1	115200	RTU(8,N,1)
GFAR-RM21	4-Channel relay module, grounded	1	115200	RTU(8,N,1)
GFAI-RM10	4-channel analog input module (± 10 VDC)	1	115200	RTU(8,N,1)
GFAI-RM11	4-channel analog input module (0...10VDC)	1	115200	RTU(8,N,1)
GFAI-RM20	4-channel analog input module (0... 20mA)	1	115200	RTU(8,N,1)
GFAI-RM21	4-channel analog input module (4... 20mA)	1	115200	RTU(8,N,1)
GFAO-RM10	4-channel analog output module (± 10 VDC)	1	115200	RTU(8,N,1)
GFAO-RM11	4-channel analog output module (-10...10VDC)	1	115200	RTU(8,N,1)
GFAO-RM20	4-channel analog output module (0... 20mA)	1	115200	RTU(8,N,1)
GFAO-RM21	4-channel analog output module (4... 20mA)	1	115200	RTU(8,N,1)
GFAX-RM10	2-channel analog input module, 2-channel analog output module (± 10 VDC)	1	115200	RTU(8,N,1)
GFAX-RM11	2-channel analog input module, 2-channel analog output module (0...10VDC)	1	115200	RTU(8,N,1)
GFAX-RM20	2-channel analog input module, 2-channel analog output module (0... 20mA)	1	115200	RTU(8,N,1)
GFAX-RM21	2-channel analog input module, 2-channel analog output module (4... 20mA)	1	115200	RTU(8,N,1)

III. etup Software Functions:

The setup software shows the I/O module station numbers, baud rates and data formats.

IV. I/O Module Settings and Connections

Connect the Micro USB port and GFTL-RM01 (RS232 converter) to your computer and open the iO-Grid M Utility program to set up I/O module parameters

I/O module connection illustration:

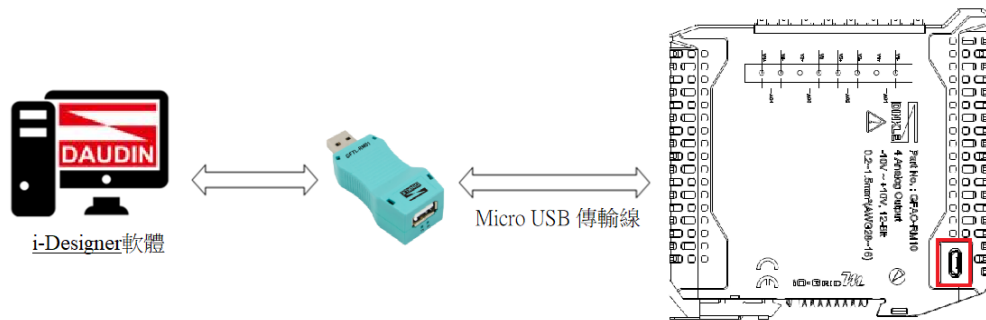

I/O module connection image:

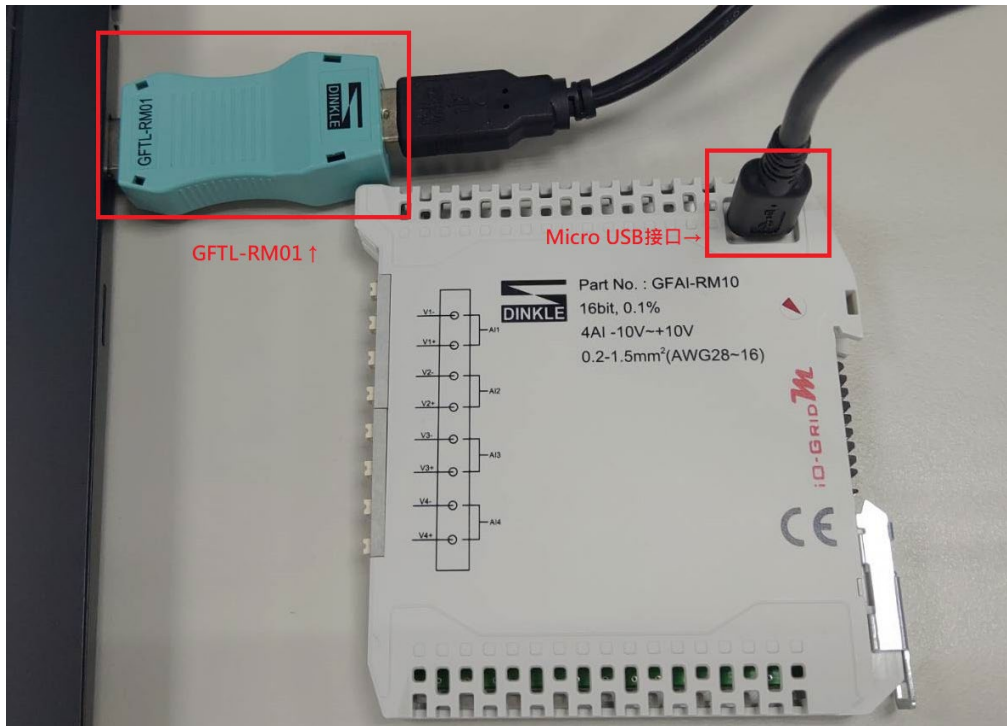

※ Please do not power the I/O module during the setup

6.2 i-Designer Program Tutorial

I. Connect to the I/O module using GFTL-RM01 and a Micro USB cable

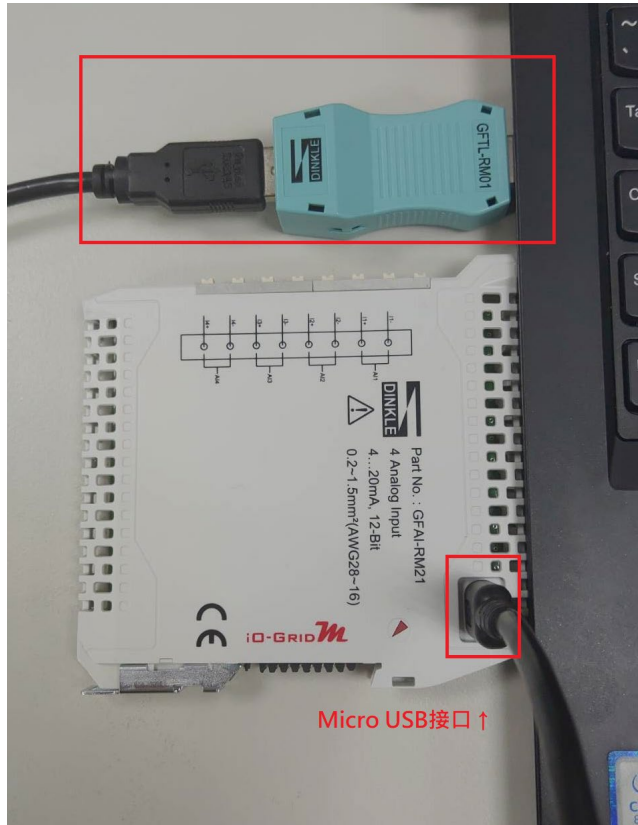

II. Click to launch the software



III. Select “M Series Module Configuration”

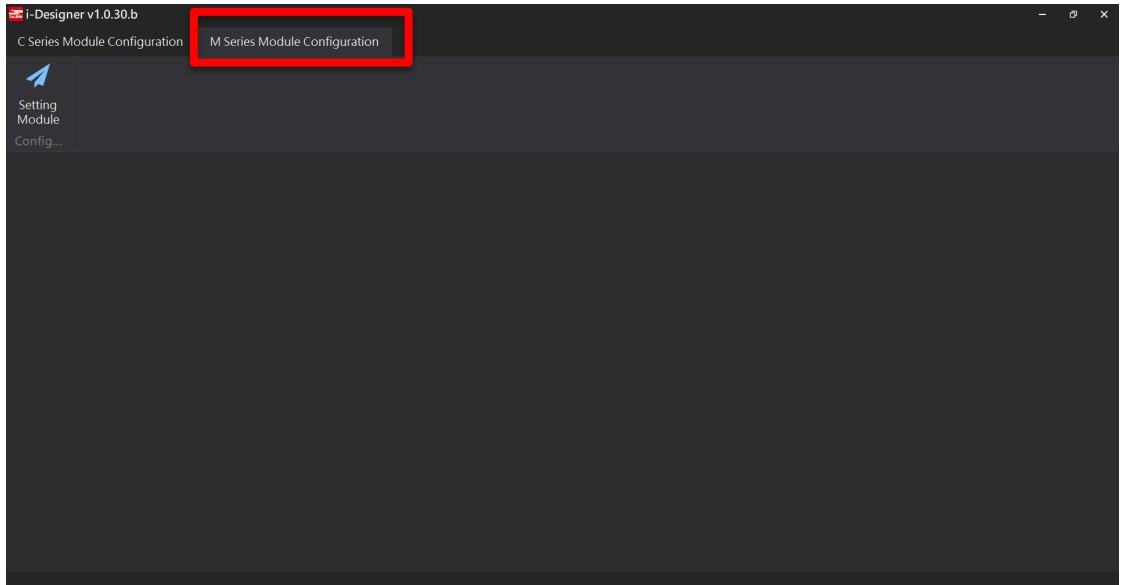

IV. Click on the “Setting Module” icon

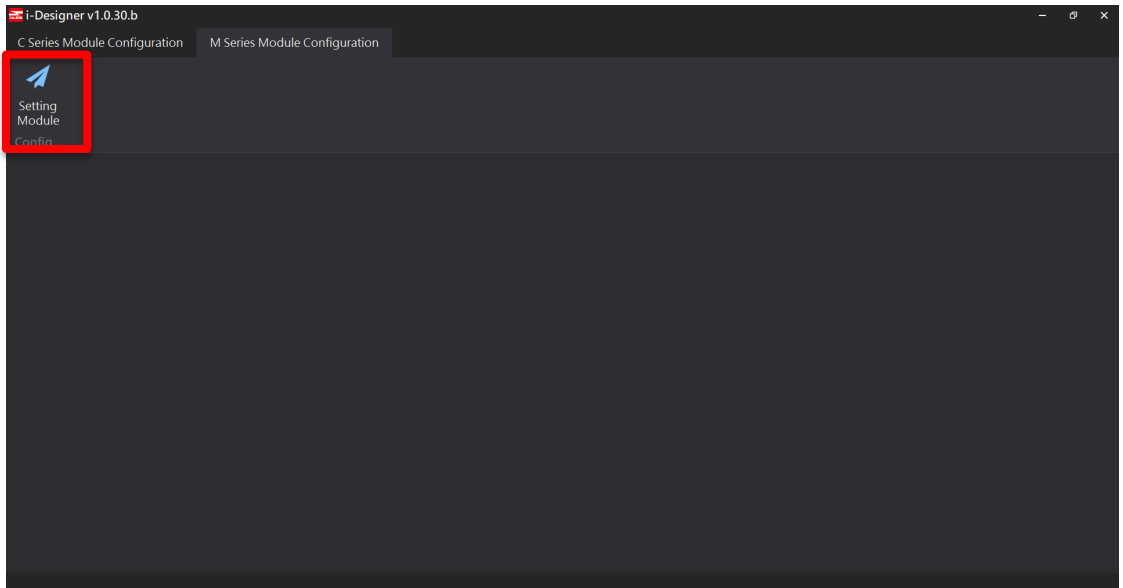

V. Enter the “Setting Module” page for M-series

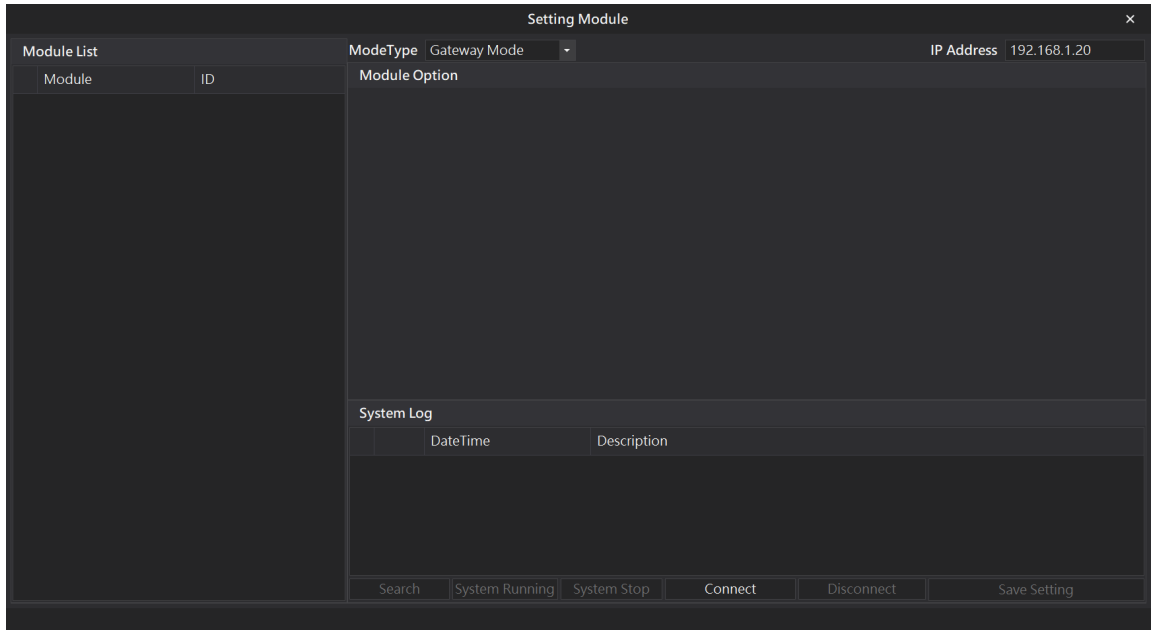

VI. Select the mode type based on the connected module

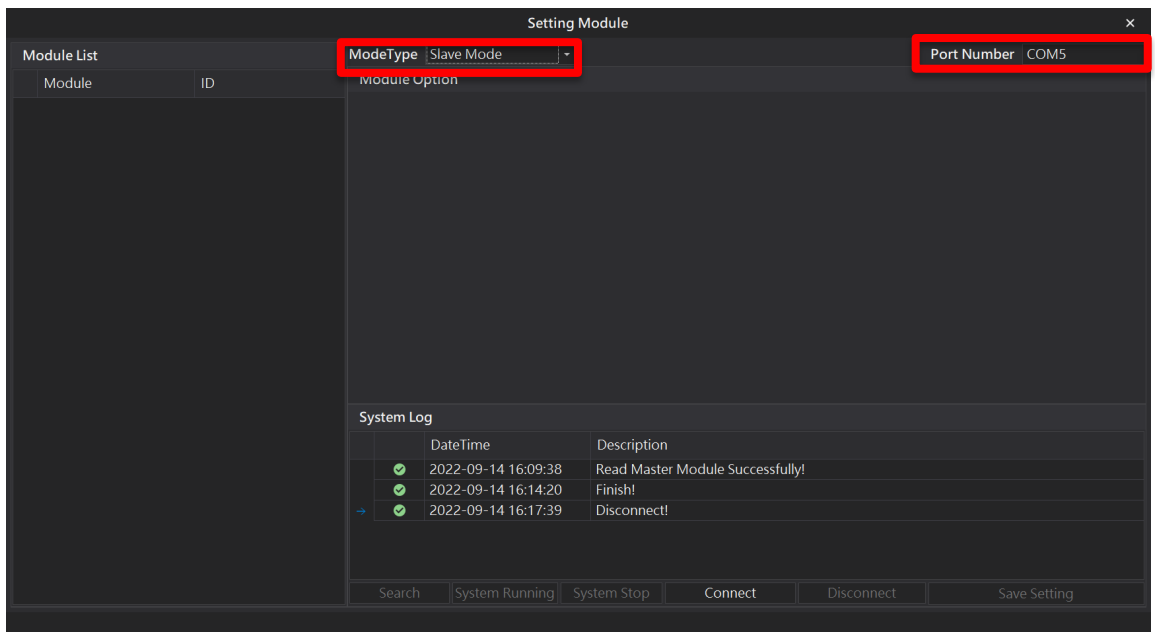

VII. Click on “Connect”

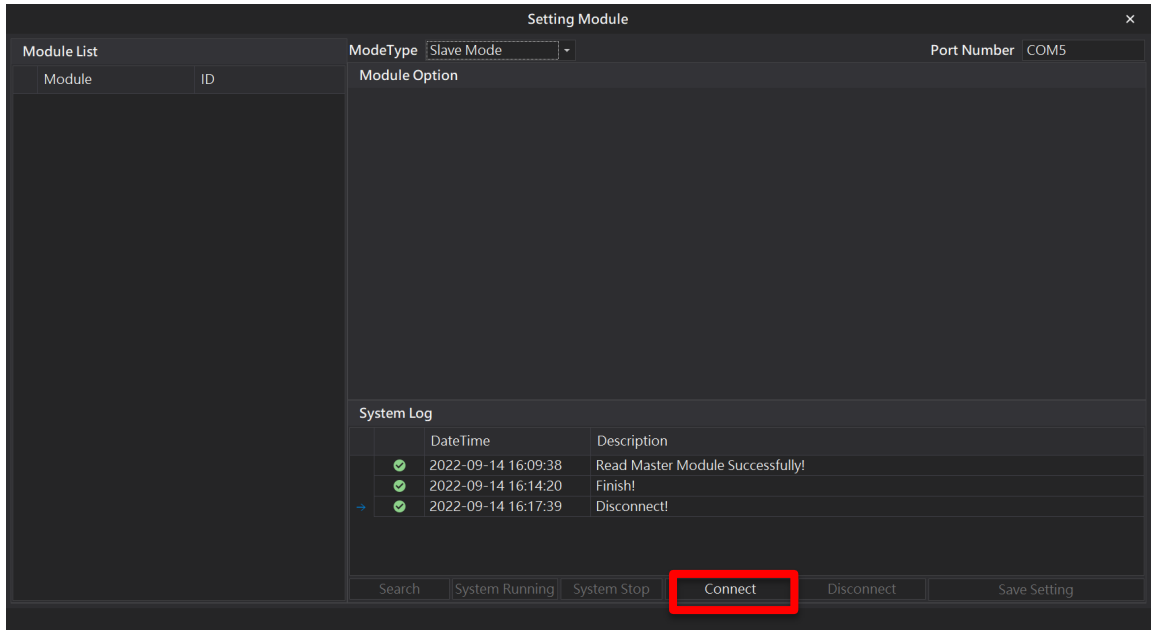

VIII. Set up I/O modules' station numbers and communication format (must click on “Save” after changing them)

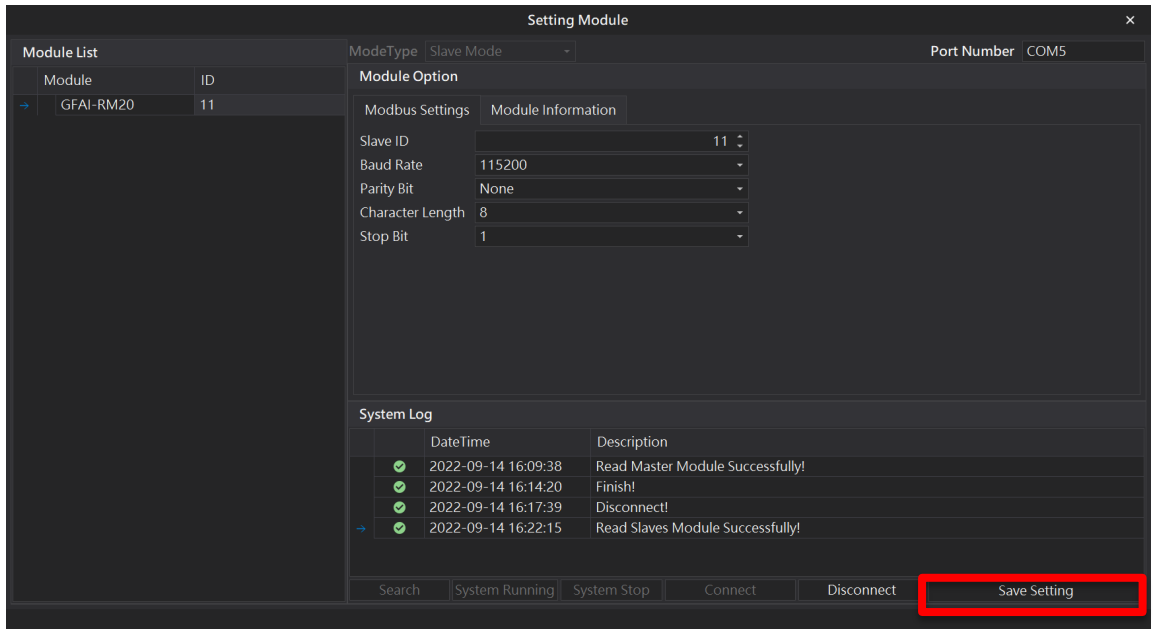

7. Digital Output Module Control Register Description

7.1 Digital Output Module Register Communication Method

I. Use Modbus RTU/ASCII to write in single-chip digital output module registers

The address for the digital output module register to be written is: 0x2000

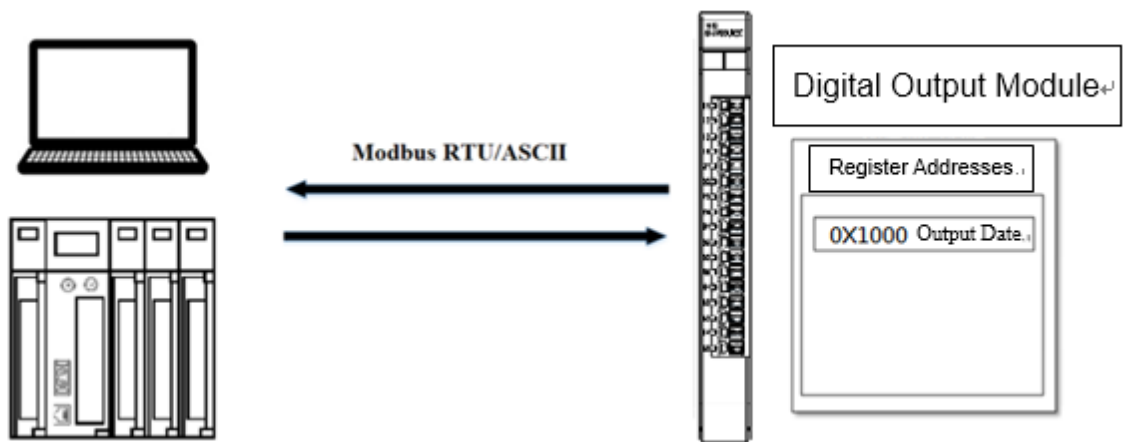

※ With no control module, RS485's physical wire must be connected with an adapter to send the signal to the Dinkle Bus

The configuration that uses Modbus RTU/ASCII to write single-chip digital output module registers is listed below:

Name/Product No.	Description
GFDO-RM01N	16-channel digital output module (sink)
GFDO-RM02N	16-channel digital output module (Source)
BS-210	Adapter
BS-211	Adapter

II. Use Modbus RTU/ASCII with control modules to write in digital output registers

Once a digital output module is set up with a control module, it will automatically assign the digital output modules' output records registers at the address of 0x2000

Example:

Two digital output module registers will at 0x2000 and 0x2001

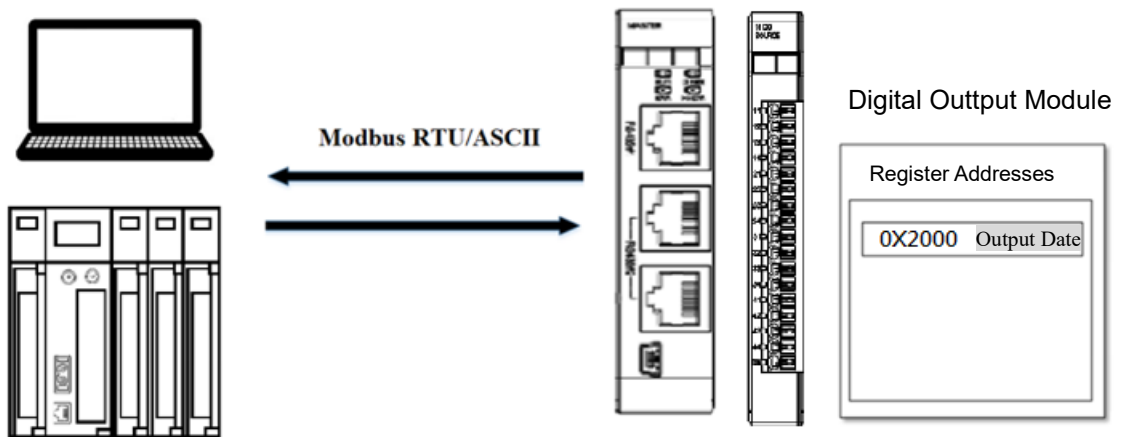

※When using control modules, RS485 can connect to control modules with 0170-0101.

The configuration that uses Modbus RTU/ASCII with a control module to write in digital output modules is listed below:

Name/Product No.	Description
GFMS-RM01S	Master Modbus RTU, 1 Port
GFDO-RM01N	16-channel digital output module (sink)
GFDO-RM02N	16-channel digital output module (Source)
0170-0101	RS485(2W)-to-RS485(RJ45 interface)

7.2 Digital Output Module Register Format Information (0x2000, rewritable)

GFDO-RM01N/ GFDO-RM02N Register Format: Channel open-1; channel closed - 0;
reserved value - 0.

Bit15	Bit14	Bit13	Bit12	Bit11	Bit10	Bit9	Bit8
Ch44	Ch43	Ch42	Ch41	Ch34	Ch33	Ch32	Ch31
Bit7	Bit6	Bit5	Bit4	Bit3	Bit2	Bit1	Bit0
Ch24	Ch23	Ch22	Ch21	Ch14	Ch13	Ch12	Ch11

Example: With all channels open: 1111 1111 1111 1111 (0xFF 0xFF);

with channel 1 to 8 open: 0000 0000 1111 1111 (0x00 0xFF);

with all channels closed: 0000 0000 0000 0000 (0x00 0x00).

7.3 Modbus function code 0x10 Demonstration

I. Use Modbus RTU/ASCII to write in single-chip digital output module registers

Modbus function code	Transmission example (ID:0x01)	Respond example (ID:0x01)
0x10	01 10 20 00 00 01 02 FF FF	01 10 20 00 00 01

※In this example, we are writing in “0x2000” with the I/O module ID of “01”

※When not using control modules for communications, the registers will be at 0x2000

II. Use Modbus RTU/ASCII with control modules to write in digital output registers

Modbus function code	Transmission example (ID:0x01)	Respond example (ID:0x01)
0x10	01 10 20 00 00 01 02 FF FF	01 10 20 00 00 01

※In this example, we are writing in “0x2000” with the control module ID of “01”

※When using control modules for communications, the registers will start at 0x2000

7.4 Supports Modbus function code

Modbus function code	Transmission example (ID :0x01)	Respond example (ID :0x01)
0x01	01 01 00 00 00 10	00 01 02 FF FF
0x05	01 05 00 00 FF 00	01 05 00 00 FF 00
0x06	01 06 20 00 FF FF	01 06 20 00 FF FF
0x0F	01 0F 00 00 00 10 02 00 01	01 0F 00 00 00 10
0x10	01 10 20 00 00 01 02 FF FF	01 10 20 00 00 01