



# **iO-GRID X Series**

## **GX-HC100**

### **Module User Manual**



Table of Contents

- 1. Introduction..... 3
- 2. Product Features ..... 3
- 2. Module Specifications ..... 6
  - 2.1 Electrical Specifications ..... 6
  - 2.2 General Specifications ..... 7
  - 2.3 High-Speed Counter Specifications ..... 8
- 3. Module Panel Introduction ..... 9
- 4. Module Installation and Removal Instructions ..... 11
  - 4.1 Installation..... 11
  - 4.2 Removal..... 12
  - 4.3 Module Dimensions..... 13
- 5. High-Count Counter Wiring Instructions ..... 14
  - 5.1 GX-HC100 ..... 14
  - 5.2 Channel A, B, Z Signal Definitions ..... 15
  - 5.3 Valid Range of Count Values ..... 16
  - 5.4 Indicator Definitions..... 17
  - 5.5 Supported Measurement Types ..... 18
  - 5.6 DI Digital Input Functions..... 19
- 6. Parameter Setting and Configuration Instructions ..... 20
  - 6.1 Product Assembly Configuration..... 20
  - 6.2 Coupler Parameter Description ..... 21
  - 6.3 Factory Defaults..... 23
  - 6.4 Error Code Lookup..... 24
- 7. Appendix I: i-Designer Instructions ..... 26
  - 7.1 Installation..... 26
  - 7.2 UI Screen Description..... 28
  - 7.3 i-Designer Information Verification ..... 33
  - 7.4 Language Settings ..... 34
  - 7.5 COM Port Connection Settings ..... 35
  - 7.6 Connection Setting Instructions ..... 37
  - 7.7 GX-HC100 Parameter Setting Explanations ..... 45
  - 7.8 Operation Parameter Definitions ..... 48
  - 7.9 Special Module Function Settings ..... 53

## 1. Introduction

GX-HC100 is a 2-channel encoder module that supports four modes: Encoder Mode, Direction Mode, Up Mode, and Down Mode. When paired with the GX series connector module, it can collect real-time data on rotational speed, frequency, angular velocity, linear speed, accumulated position, and pulse count, enabling motion control.

## 2. Product Features

- The module supports 2 channels of encoder input.
- Each encoder channel supports A/B incremental encoders or pulse-direction encoders.
- Each encoder channel supports orthogonal A/B signal input, with an input voltage of 24V, and is compatible with both sourcing and sinking input types.
- The Incremental Encoder Mode supports selectable frequency multiplication (x1/x2/x4).
- The Pulse-direction Mode accepts pulse input without a direction signal.
- Each encoder channel supports 1 digital input signal with a 24Vdc input voltage.
- Each encoder channel supports 1 digital output signal with a 24Vdc output voltage.
- Each encoder channel provides 1 24V power output to power the encoder.
- The internal bus and field inputs are isolated.
- The module includes 17 LED indicators.
- The maximum input frequency supported by the module is 500kHz.
- The module includes measurement functions that can detect load speed or input signal frequency.

**Caution (ATTENTION):**

1. THIS DEVICE IS FOR INDOOR USE ONLY, DON'T PUT OR USE IT IN HIGH TEMPERATURE AND HIGH MOISTURE ENVIRONMENT.

CET EQUIPEMENT EST DESTINE A UN USAGE INTERIEUR UNIQUEMENT NE PAS STOCKER OU UTILISER DANS UN ENVIRONNEMENT A HAUTE TEMPERATURE ET HAUTE HUMIDITE.

2. AVOID FALLING AND BUMPING OTHERWISE THE ELECTRICAL COMPONENTS WILL BE DAMAGED.

ÉVITEZ DE TOMBER ET DE VOUS ÉCRASER, SINON LES COMPOSANTS ÉLECTRIQUES SERONT ENDOMMAGÉS

3. DON'T TRY TO DISASSEMBLE OR OPEN THE COVER UNDER ANY CIRCUMSTANCE IN ORDER TO AVOID DANGER.

NE TENTEZ JAMAIS DE DEBALLER OU D'OUVRIR LE COUVERCLE POUR EVITER TOUT DANGER.

4. IF THE EQUIPMENT IS USED IN A MANNER NOT SPECIFIED BY THE MANUFACTURER, THE PROTECTION PROVIDED BY THE EQUIPMENT MAY BE IMPAIRED.

SI L'APPAREIL N'EST PAS UTILISE DE LA MANIERE INDIQUEE PAR LE FABRICANT, LA PROTECTION FOURNIE PAR L'APPAREIL PEUT ETRE ALTEREE.

5. THE INSTALLATION THAT THE SAFETY OF ANY SYSTEM INCORPORATING THE EQUIPMENT IS THE RESPONSIBILITY OF THE ASSEMBLER OF THE SYSTEM.

L'INSTALLATION DE TOUT SYSTÈME INTÉGRANT CET ÉQUIPEMENT EST LA RESPONSABILITÉ DU CONSTRUCTEUR DU SYSTÈME.

6. USE WITH COPPER CONDUCTORS ONLY. INPUT WIRING: MINIMUM 28 AWG, 85°C, OUTPUT WIRING: MINIMUM 28 AWG, 85°C

DESTINÉ À ÊTRE UTILISÉ AVEC DES CONDUCTEURS EN CUIVRE SEULEMENT. CABLAGE D'ENTREE: MINIMUM 28 AWG, 85 ° C. CABLAGE DE SORTIE: MINIMUM 28 AWG, 85 ° C.

7. FOR USE IN A CONTROLLED ENVIRONMENT. REFER TO MANUAL FOR ENVIRONMENTAL CONDITIONS.

POUR UN ENVIRONNEMENT CONTROLE. REPORTEZ-VOUS AU MANUEL DES CONDITIONS ENVIRONNEMENTALES.

8. DISCONNECT ALL SOURCES OF SUPPLY BEFORE SERVICING.

COUPER TOUTES LES SOURCES D'ALIMENTATION AVANT DE FAIRE L'ENTRETIEN ET LES RÉPARATIONS.

9. PROPER VENTILATION IS REQUIRED TO REDUCE THE RISK OF HAZARDOUS OR EXPLOSIVE GAS BUILDUP DURING INDOOR CHARGING. SEE OWNERS MANUAL.



UNE VENTILATION ADÉQUATE EST NÉCESSAIRE AFIN DE RÉDUIRE LES RISQUES D'ACCUMULATION DE GAZ DANGEREUX OU EXPLOSIFS DURANT LA RECHARGE À L'INTÉRIEUR. VOIR LE MANUEL D'ENTRETIEN.

10. PLEASE BE SURE TO USE CERTIFIED POWER SUPPLY WITH SELV OUTPUT OR CERTIFIED POWER SUPPLY PROVIDING DOUBLE INSULATION EVALUATED BY UL60950-1, UL 62368-1, OR UL61010-1 AND UL61010-2-201 STANDARDS.

VEUILLEZ VOUS ASSURER D'UTILISER UNE ALIMENTATION CERTIFIÉE AVEC SORTIE SELV OU UNE ALIMENTATION CERTIFIÉE OFFRANT UNE DOUBLE ISOLATION ÉVALUÉE PAR LES NORMES UL60950-1 OU UL 62368-1 OU UL61010-1 ET UL61010-2-201.

## 2. Module Specifications

### 2.1 Electrical Specifications

Electrical Specifications		
Encoder Module	Working Voltage	24 VDC (-15%~+20%)
	Working Current	Max. 160mA@24VDC

## 2.2 General Specifications

General Specifications		
Size (W x D x H)	Coupler	25 x 105 x 69mm
	I/O Module	12 x 105 x 69mm
Weight	Coupler	80g
	I/O Module	62g
Operating Temperature	0 ... +60°C	
Storage Temperature	-25°C...+85°C	
Relative Humidity	RH 95%, non-condensing	
Altitude Limit	< 2000m	
IP Protection Level	IP 20	
Pollution Degree	II	
Safety Certifications	CE	
Wire Gauge Range (IEC / UL)	0.2mm <sup>2</sup> ~ 1.5mm <sup>2</sup> / AWG 24~16	
Recommended Terminals	DN00510D DN00710D	

## 2.3 High-Speed Counter Specifications

High-Speed Counter Specifications	
Number of Channels	2 channels
Field Power Supply (Field)	24 VDC (-15%~+20%)
Field Power Supply (System)	5VDC
A, B, Z Signal Type	SINK/SOURCE (single-ended signal)
Maximum Input Frequency	≤ 500KHz
Encoder Frequency Mode	x1/ x2/ x4
Encoder Resolution	1~65535
Z Reset Function	Supported
Count Range	Int32 (-2147483648 ~ 2147483647)
Counting Mode	Encoder Mode / Direction Mode / Up Mode / Down Mode
Measurement Function	Rotational Speed / Frequency / Angular Velocity / Linear Speed / Accumulated Position / Accumulated Pulse Count
Power Loss Backup	Count Values, Accumulated Pulse Count

High-Speed Counter Specifications	
Number of Digital Output Channels	2 channels
Digital Output Type	SOURCE
Maximum Output Current for Single Channel	0.5A
Number of Digital Input Channels	2 channels
Digital Input Type	SINK/ SOURCE
Digital Input Functions	General Mode / Capture Count Mode
Indicators	1 system power status (green) 1 field power status (green) 1 error status (red) 6 channel signal status (green) 2 output status indicators (green) 2 input status indicators (green) 4 count direction indicators (green)



### 3. Module Panel Introduction

#### GX-HC100 Specifications

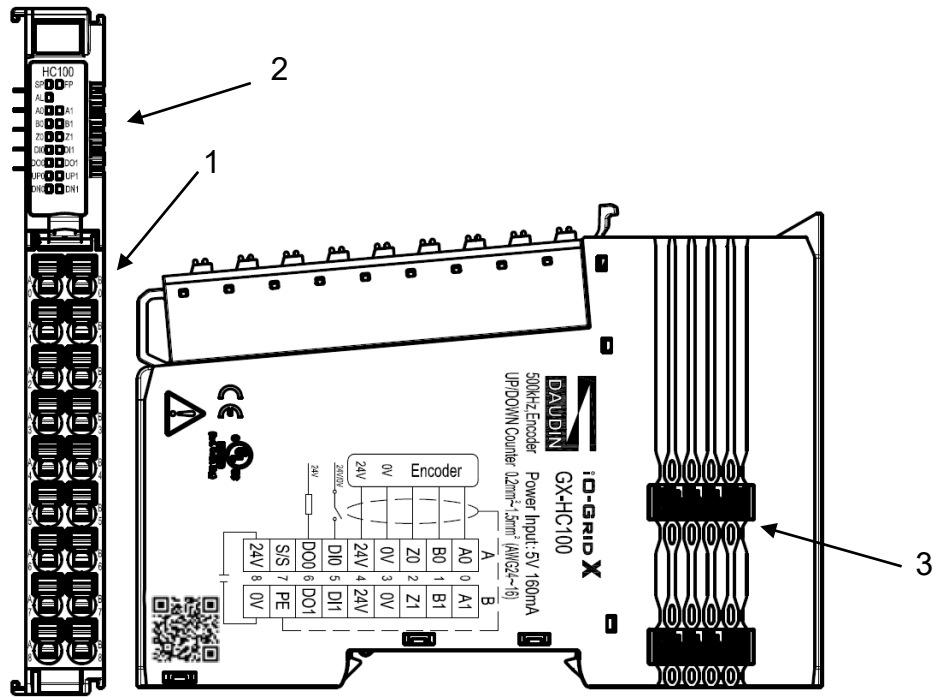

Figure 3.1 GX-HC100

NO.	Name	Description
1	Signal Terminal	Input signal interface with plug-in terminals
2	Channel Status Indicator	14xLED
3	System Bus	Interface for communication and power supply



**GX-HC100 Indicator Definitions**

Label	Name	Description
SP	System Power Indicator	Steady on: System power supply is normal Off: No power or power supply issue
FP	Field Power Indicator	Steady on: Field power supply is normal Off: No power or power supply issue
AL	Error Status Indicator	Fast blink: Station configuration incomplete Slow blink: System error has occurred (e.g., field power supply issue) Off: No system errors
Ax Bx Zx DIx	CHx Input Signal Indicator	On: CHx has valid input signal Off: CHx has no valid input signal
DOx	CHx Digital Output Signal Indicator:	On: CHx DO signal output at high level Off: CHx DO signal output at low level / no output
UPx	CHx Up Mode Status Indicator	Off: CHx encoder has no input signal or is rotating in reverse On: CHx encoder is rotating forward
DNx	CHx Down Mode Status Indicator	Off: CHx encoder has no input signal or is rotating forward On: CHx encoder is rotating in reverse

## 4. Module Installation and Removal Instructions

### 4.1 Installation

Align each module unit's side with the direction indicated by the arrow, and snap it onto the upper side of the DIN rail.

Once each unit is positioned, the clip automatically locks onto the rail.

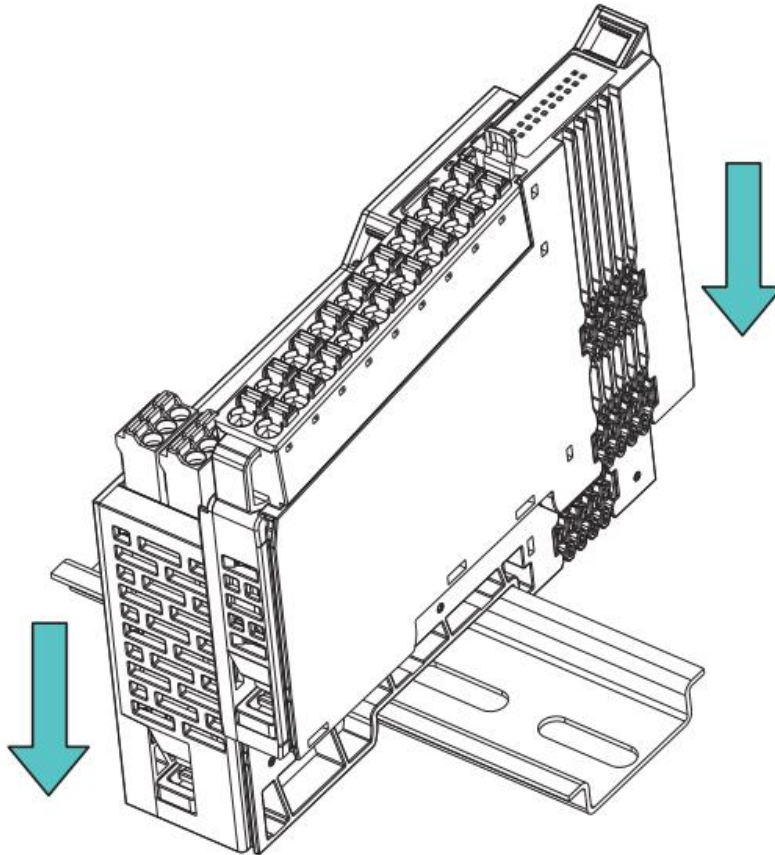

Figure 4.1 Module Installation Diagram

※Note: If the clip fails to engage, press the top of the clip to reset and secure it to the rail.

## 4.2 Removal

Use a screwdriver to pull down the plastic hook on each unit module.

Following the reverse order of installation, remove each module unit from the DIN rail.

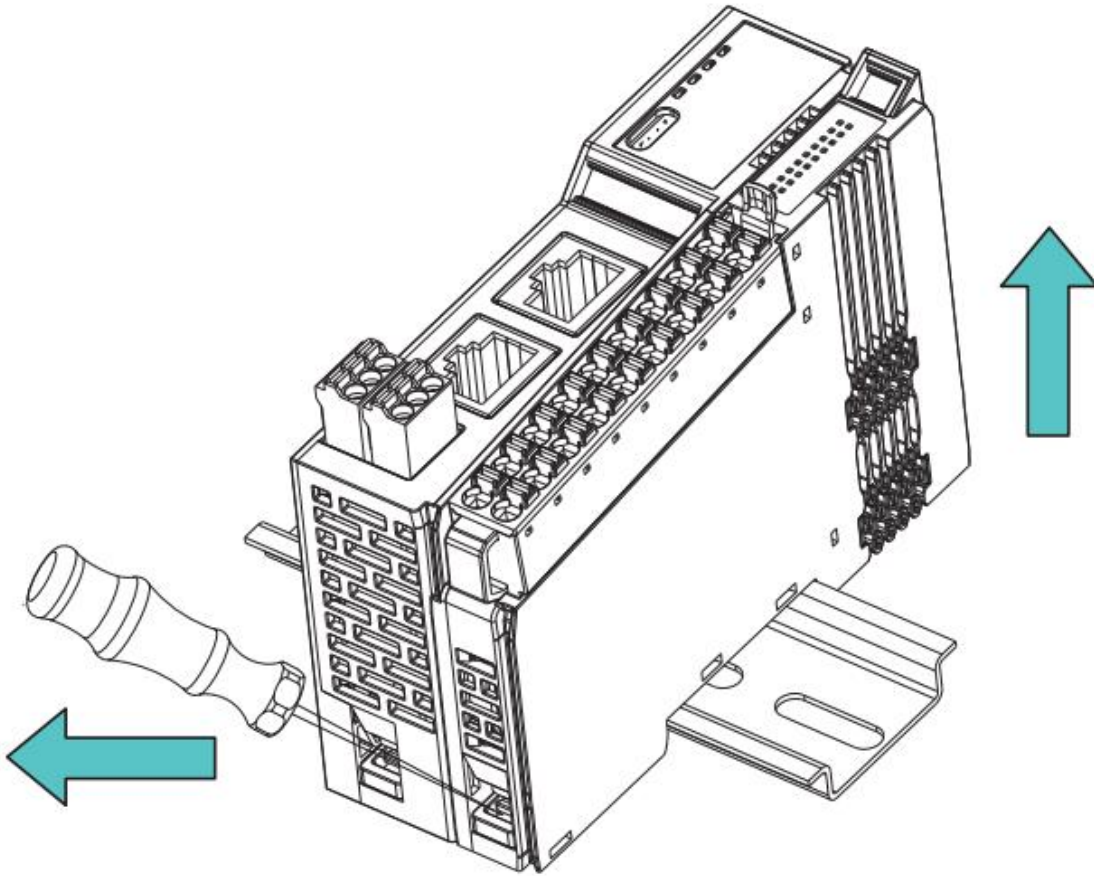

Figure 4.2 Module Removal Diagram

### 4.3 Module Dimensions

#### 4.3.1. I/O and Functional Module Dimensions

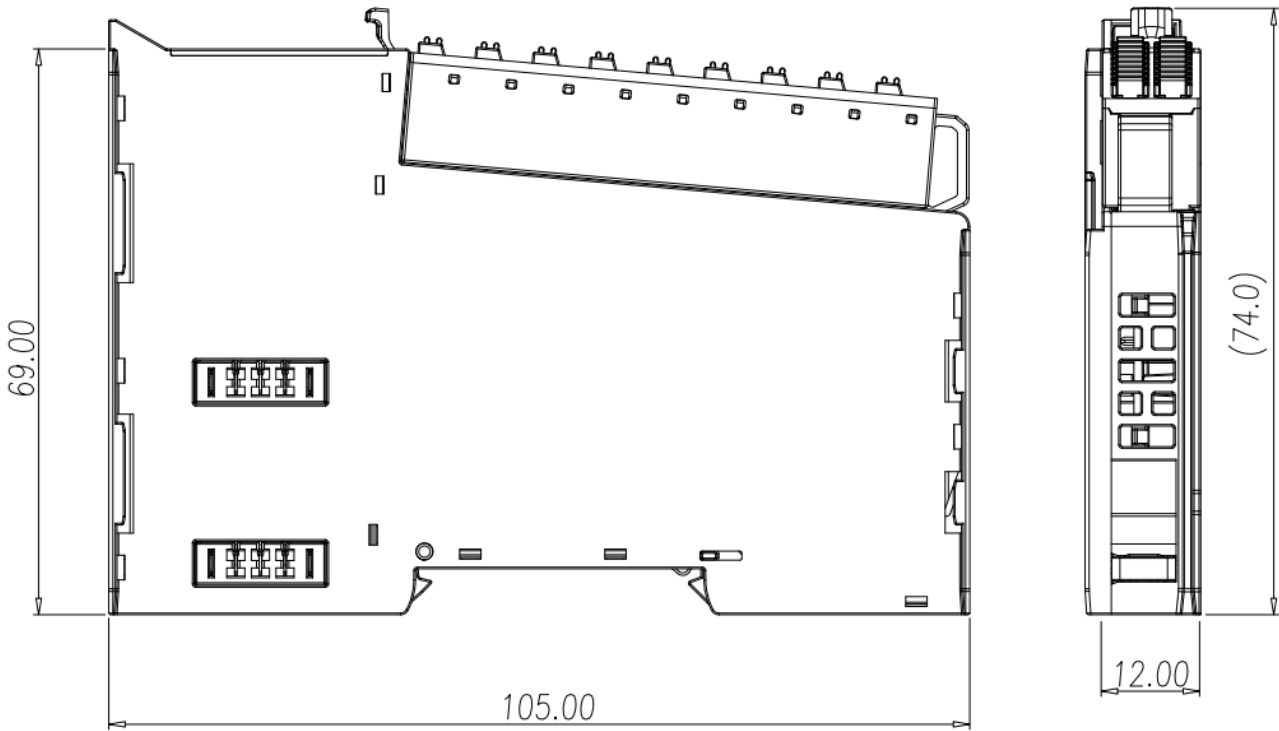

Figure 4.4 I/O Module Dimension Diagram

## 5. High-Count Counter Wiring Instructions

### 5.1 GX-HC100

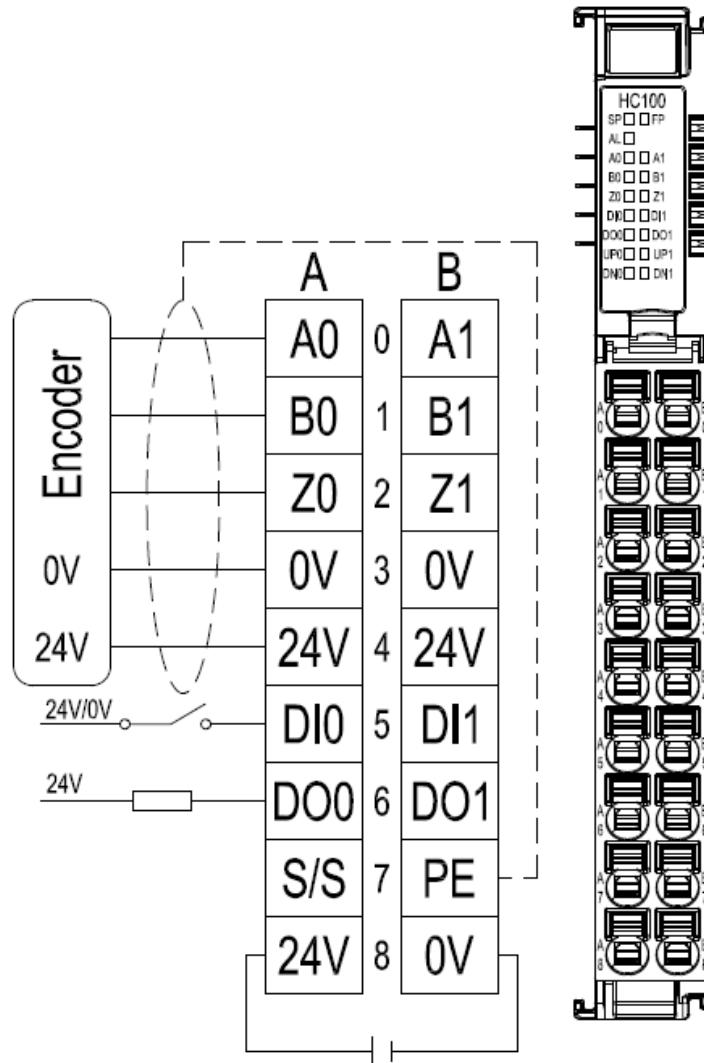
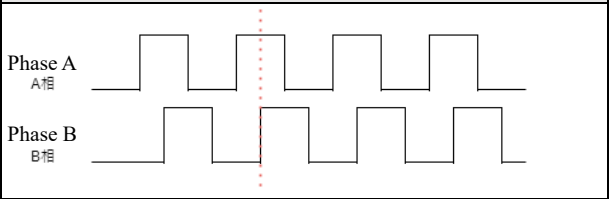
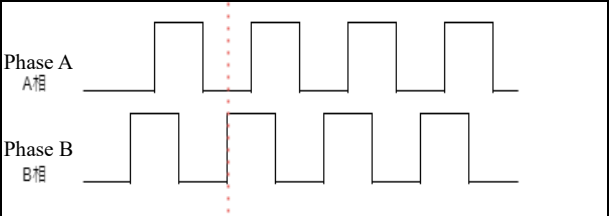
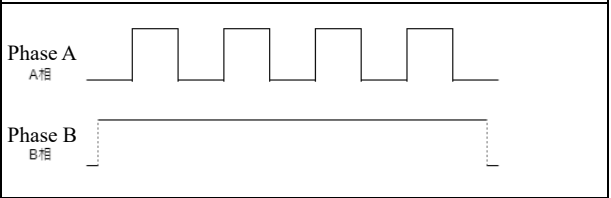
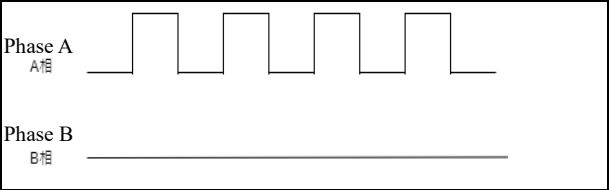
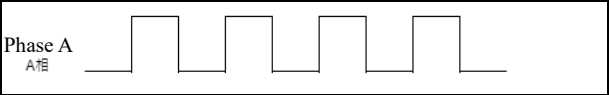
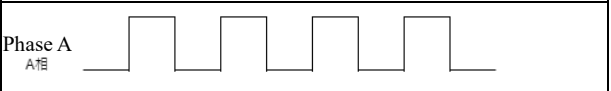
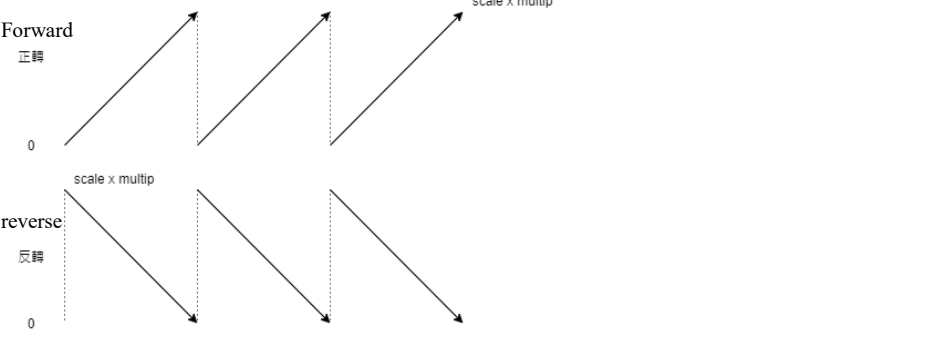
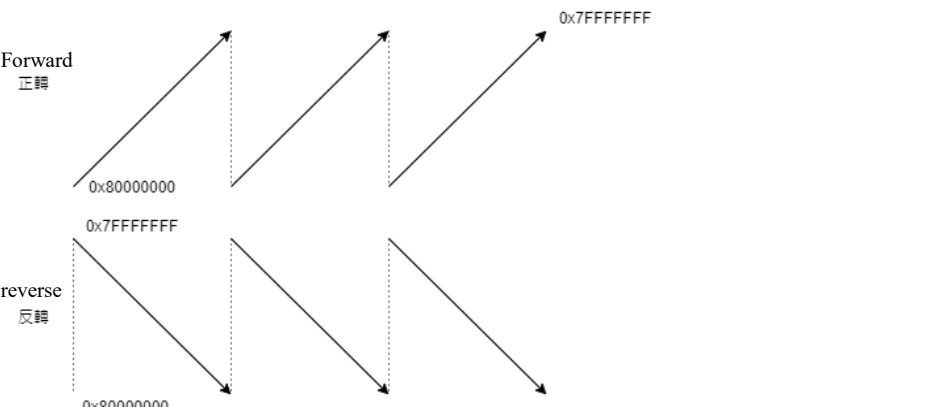
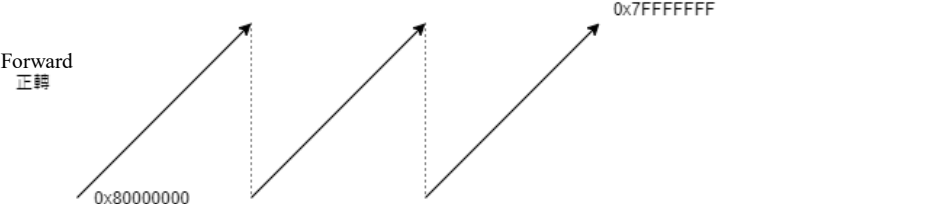
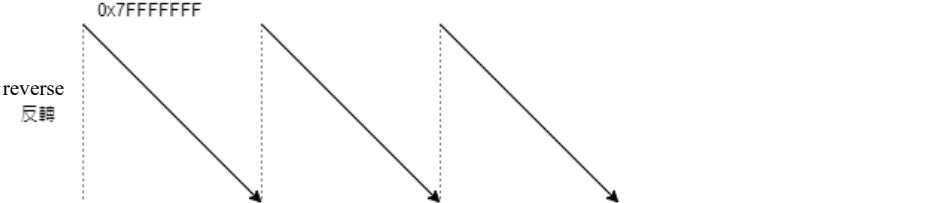

Figure 5.1 GX-HC100 Wiring Diagram

## 5.2 Channel A, B, Z Signal Definitions

Counting Mode		
<b>Encoder Mode</b>	Forward Rotation Signal Input	
	Reverse Rotation Signal Input	
	Z	Reset Count Value
<b>Direction Mode</b>	Forward Rotation Signal Input	
	Reverse Rotation Signal Input	
<b>Up Mode</b>	Forward Rotation Signal Input	
	Reverse Rotation Signal Input	-
<b>Down Mode</b>	Forward Rotation Signal Input	-
	Reverse Rotation Signal Input	

### 5.3 Valid Range of Count Values

Counting Mode	Count Range
<b>Encoder Mode</b>	 <p>Forward 正轉</p> <p>0</p> <p>scale x multip</p> <p>reverse 反轉</p> <p>0</p> <p>scale x multip</p>
<b>Direction Mode</b>	 <p>Forward 正轉</p> <p>0x80000000</p> <p>0x7FFFFFFF</p> <p>reverse 反轉</p> <p>0x80000000</p> <p>0x7FFFFFFF</p>
<b>Up Mode</b>	 <p>Forward 正轉</p> <p>0x80000000</p> <p>0x7FFFFFFF</p>
<b>Down Mode</b>	 <p>reverse 反轉</p> <p>0x7FFFFFFF</p> <p>0x80000000</p>



## 5.4 Indicator Definitions

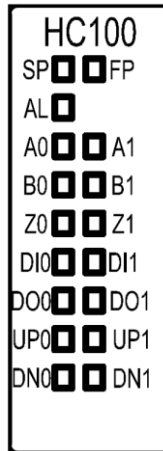

Figure 5.2 Indicator Diagram

Indicators	Description
System Power Status (SP) (Green)	Off: No power or power issue Steady on: System power supply is normal
Field Power Status (FP) (Green)	Off: No power or power issue Steady on: System power supply is normal
Error Status (AL) (Red)	Off: No system errors Fast blink: Station configuration incomplete Slow blink: System error has occurred (e.g., field power supply issue)
A0/B0/Z0 Encoder Signal Indicator	Off: Channel 1 input signal A/B/Z is invalid On: Channel 1 input signal A/B/Z is valid
A1/B1/Z1 Encoder Signal Indicator	Off: Channel 2 input signal A/B/Z is invalid On: Channel 2 input signal A/B/Z is valid
DI# Input Indicator	Off: Channel # input signal DI is invalid On: Channel # input signal DI is valid
DO# Output Indicator	Off: Channel # output signal DO is invalid On: Channel # output signal DO is valid
UP# Indicator	Off: Channel # encoder has no input signal or rotates in reverse On: Channel # encoder rotates forward
Channel Indicators	Off: Channel # encoder has no input signal or rotates forward On: Channel # encoder rotates in reverse

## 5.5 Supported Measurement Types

Type	Definition	Supports Floating Point Precision
None (Default)	Measurement value is 0	
Rotation Speed (rpm)	Revolutions per minute *Based on resolution setting	Supported
Frequency (Hz)	Number of pulses per second	
Angular Velocity (deg/ms)	Degrees moved per millisecond *Based on resolution setting	Supported
Linear Velocity (mm/ms)	Distance moved in mm per millisecond *Based on resolution and radius settings	Supported
Linear Velocity (mm/s)	Distance moved in mm per second *Based on resolution and radius settings	Supported
Linear Velocity (m/min)	Distance moved in meters per minute *Based on resolution and radius settings	Supported
Cumulative Position (mm)	Position converted from cumulative pulse count *Direction-sensitive *Based on single pulse distance	Supported
Cumulative Pulse Count	Cumulative Pulse Count *Direction-sensitive	

## 5.6 DI Digital Input Functions

Digital Input	Description	
DI Input Types	SINK: Pin A7 connected to 24V SOURCE: Pin A7 connected to 0V	
DIx Functional Modes	Normal DI Function	<ul style="list-style-type: none"> <li>● Digital Input bit displays input status</li> <li>● Indicator light DIx shows input status</li> </ul>
	Pulse Counting Function	<ul style="list-style-type: none"> <li>● Digital Input bit displays input status</li> <li>● Indicator light DIx shows input status</li> <li>● DIx counting function achieved using rising/falling/both edge triggers, stored in input data as int32 type</li> </ul>

## 6. Parameter Setting and Configuration Instructions

### 6.1 Product Assembly Configuration

As shown in the image below, product configuration primarily involves couplers and I/O modules.

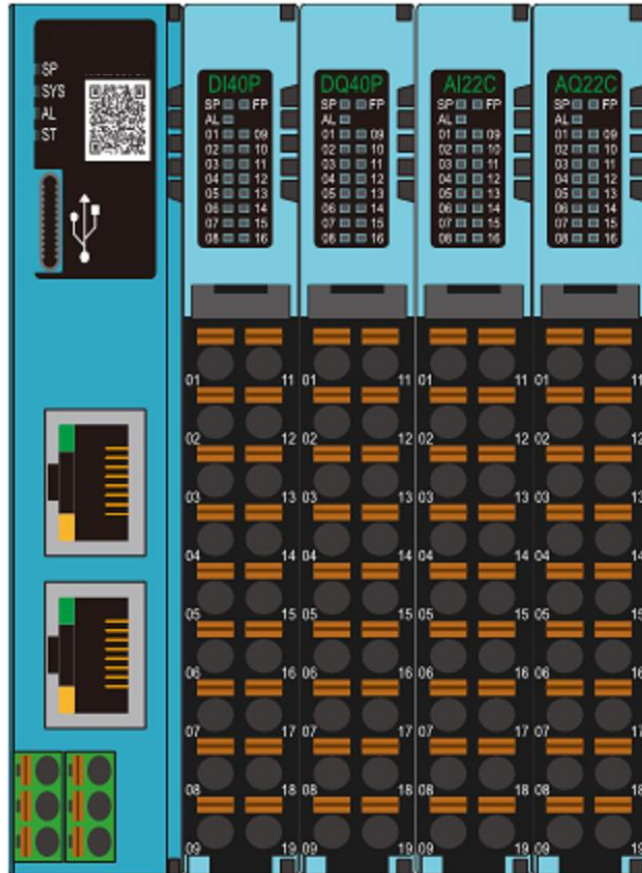

Figure 6.1

#### Quantity Limit for Configuration

1. A maximum of 64 physical I/O modules can be configured on the coupler.
2. The coupler supports up to 64 modules in total, including both expanded virtual and physical modules.

#### Virtual Module Limitations

Currently, only GX-CM111 applications are supported. For expanded commands, the virtual module configuration limit is set to 32.

## 6.2 Coupler Parameter Description

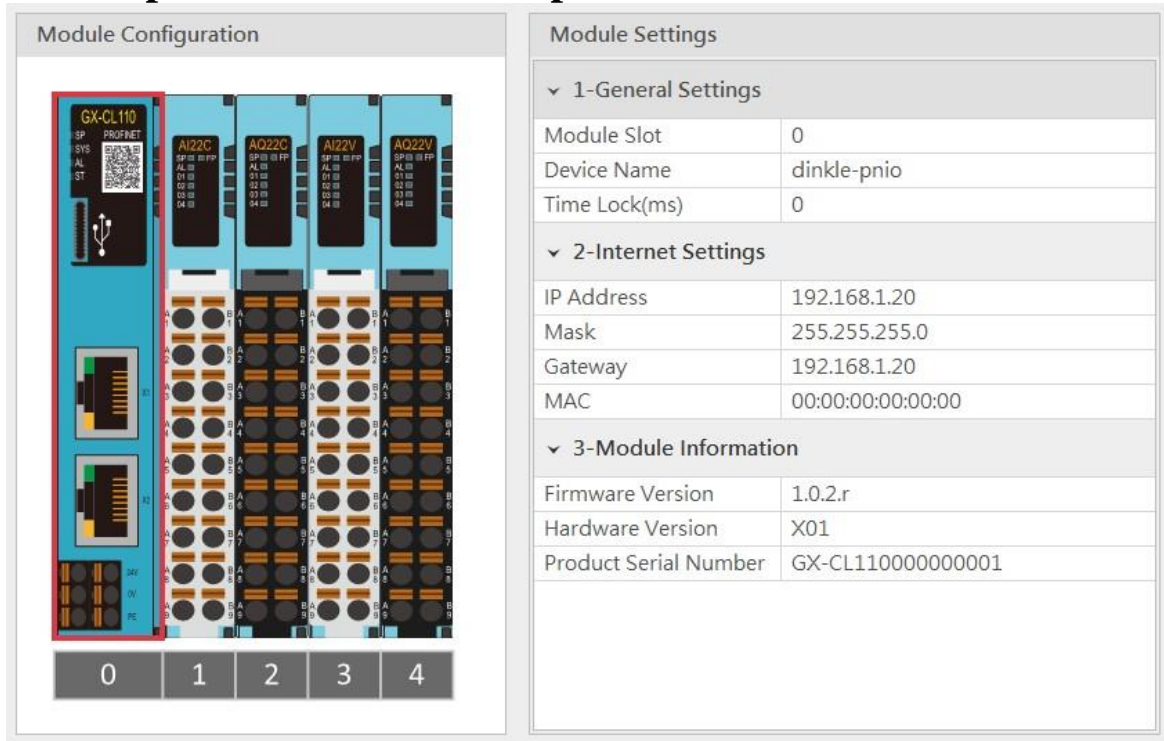

Module Configuration	
	
Module Settings	
<b>1-General Settings</b>	
Module Slot	0
Device Name	dinkle-pnio
Time Lock(ms)	0
<b>2-Internet Settings</b>	
IP Address	192.168.1.20
Mask	255.255.255.0
Gateway	192.168.1.20
MAC	00:00:00:00:00:00
<b>3-Module Information</b>	
Firmware Version	1.0.2.r
Hardware Version	X01
Product Serial Number	GX-CL110000000001

Figure 6.2 Coupler Parameters

### 6.2.1. General Settings

- Module Slot: Slot number (position); fixed at 0 for the coupler.
- Device Name: Used for name recognition in Profinet network communication. Follow standard naming conventions for the settings.
- Reset Time: Defaults to 0 if not set, meaning the reset function is disabled. If the timeout parameter is set to 1000, it means that within 1 second, the module must exchange IO data with the host computer. If no data exchange occurs within this set time, the module will set the output channels to 0..

### 6.2.2. Network Settings

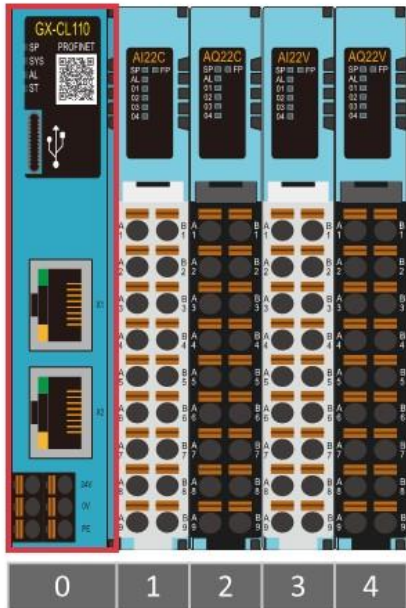
- IP Address: Can be configured in IPv4 network address format, with a default factory setting of 192.168.1.20.
- Subnet Mask: Configurable; default setting is 255.255.255.0.
- Default Gateway: Configurable; default setting is 19.168.1.20.
- Physical Address: Not configurable; MAC address is factory-set for network identification of different device modules.

### 6.2.3. Module Information

- Firmware Version: Current module firmware version
- Hardware Version: Module hardware design version
- Product Serial Number: Unique identifier for Daudin products

As shown in Figure 6.2, all parameters (except MAC) can be configured as needed. After completing the settings, proceed to upload the parameters as shown in Figure 6.3.

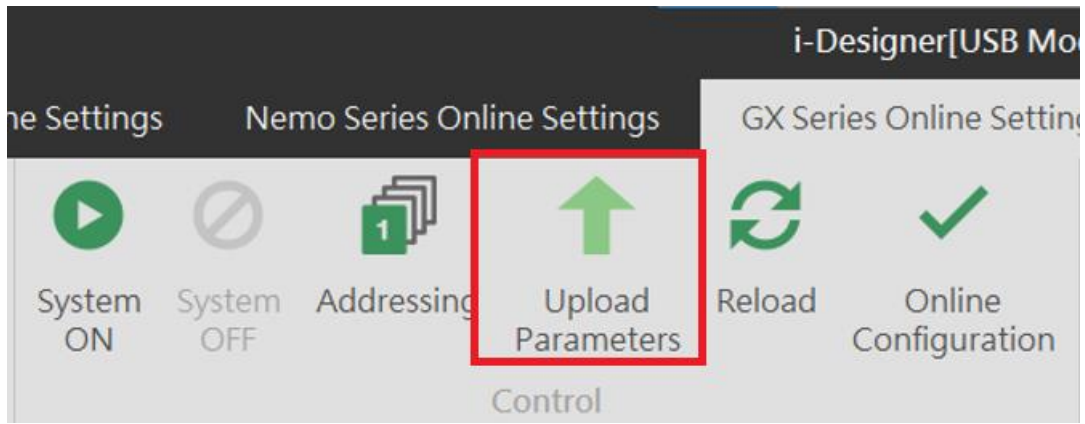

Figure 6.3 Upload Parameters



Before proceeding with relevant settings, the system operation must be paused.

### 6.3 Factory Defaults

Apart from setting parameters through i-Designer, users can also reset system parameters using the reset button located inside the side casing.

Press Time/Mode	Application Mode
<b>Light Press (&lt;6 seconds)</b>	Module restart (RESET)
<b>Long Press (&gt;6 seconds)</b>	Restore default parameters (Application Mode) <sup>Note</sup>

Note: When the user presses the reset button for more than six seconds, the SYS light will illuminate red. After releasing the button, the red light will flash, indicating that the default parameters have been restored.

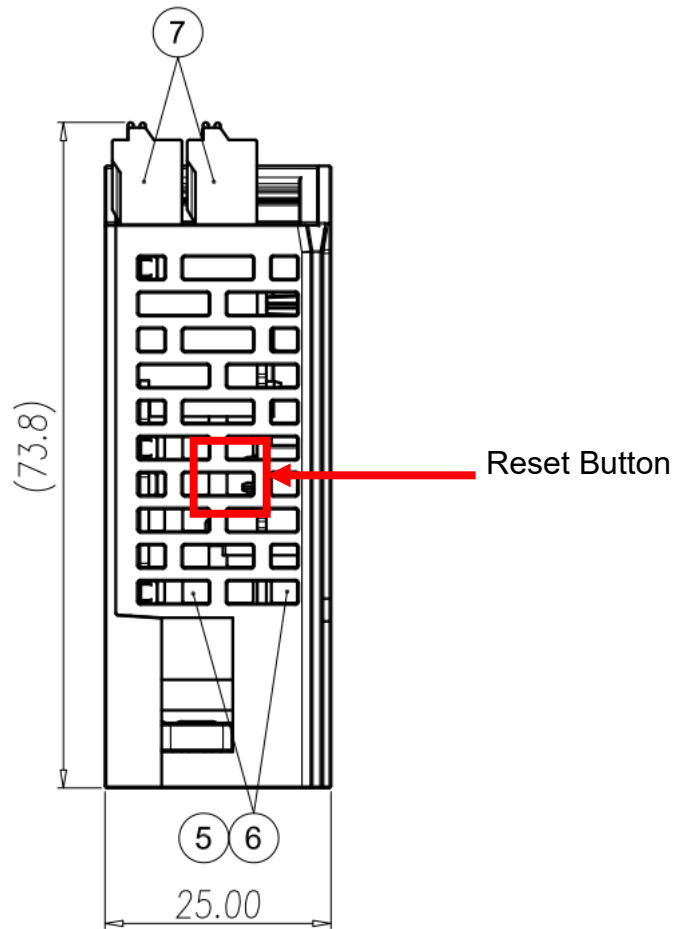

Figure 6.5 System Reset Button

## 6.4 Error Code Lookup

Users can query system error information and identify timed-out physical modules via the error code module (virtual module). Upon completion of system boot and station setup, the system will automatically place the Error Code Module in the last three available slots, one after another. If no empty slots are available, the system will automatically ignore this placement.

Error Code	Purpose	Length (Word)
System Error	System error information	2
Error Module (01-32)	Physical modules 1-32 triggering timeout	2
Error Module (33-64)	Physical modules 33-64 triggering timeout	2

System Error: System error log, 32-bit data ordered from HSB to LSB

Description	System Error [4 Byte]							
	Bit 7	Bit 6	Bit 5	Bit 4	Bit 3	Bit 2	Bit 1	Bit 0
System Error [3]	Reserved							
System Error [2]	Reserved						Err17	Err16
System Error [1]	Err15	Err14	Err13	Err12	Err11	Err10	Err9	Err8
System Error [0]	Err7	Err6	Err5	Err4	Err3	Err2	Err1	Err0

Err0: Reserved

Err1: Bit set to 1 (Coupler/IO module): Indicates the first boot, with no relevant data in memory

Err2: Bit set to 1 (Coupler/IO module): Indicates memory exceeds the planned size

Err3: Bit set to 1 (Coupler/IO module): Indicates a Checksum error

Err4: Bit set to 1 (Coupler/IO module): Indicates boot failure

Err5: Bit set to 1 (IO module): Indicates that the power is not supplied to the load side of the IO module

Err6: Bit set to 1 (IO module): Indicates IO module over-voltage/over-current

Err7: Bit set to 1 (IO module): Indicates ADC read error in the analog module

Err8: Bit set to 1 (Coupler/IO module): Indicates memory write/erase operation failed

Err9: Bit set to 1 (Coupler): Indicates no saved station record in memory

Err10: Bit set to 1 (Coupler): Indicates the memory station record differs from the boot scan

Err11: Bit set to 1 (Coupler): Indicates no module station number was detected in the boot scan

Err12: Bit set to 1 (Coupler): Indicates communication timeout in Polling Mode for IO modules

Err13: Bit set to 1 (Coupler): Indicates station failure

Err14: Bit set to 1 (Coupler/IO module): Indicates data length in operating mode exceeds the set value

Err15: Bit set to 1 (Coupler): Indicates hot-swap function recovery failure

Err16: Bit set to 1 (Coupler): Indicates network initialization failure

Err17: Bit set to 1 (Coupler): Indicates register address exceeds the control range



Error Module (01-32): Records IO module timeout information, 32-bit data ordered from HSB to LSB

Description	Error Module (01-32) [4 Byte]							
	Bit 7	Bit 6	Bit 5	Bit 4	Bit 3	Bit 2	Bit 1	Bit 0
Module Error [3]	Slot32	Slot31	Slot30	Slot29	Slot28	Slot27	Slot26	Slot25
Module Error [2]	Slot24	Slot23	Slot22	Slot21	Slot20	Slot19	Slot18	Slot17
Module Error [1]	Slot16	Slot15	Slot14	Slot13	Slot12	Slot11	Slot10	Slot9
Module Error [0]	Slot8	Slot7	Slot6	Slot5	Slot4	Slot3	Slot2	Slot1

Slot1: IO module ID 1; Bit set to 1 indicates polling timeout for this module

Slot2: IO module ID 2; Bit set to 1 indicates polling timeout for this module

Slot3: IO module ID 3; Bit set to 1 indicates polling timeout for this module

:

(and so on)

:

Slot32: IO module ID 32; Bit set to 1 indicates polling timeout for this module

Error Module (33-64) : Records IO module timeout information, 32-bit data ordered from HSB to LSB

Description	Error Module (33-64) [4 Byte]							
	Bit 7	Bit 6	Bit 5	Bit 4	Bit 3	Bit 2	Bit 1	Bit 0
Module Error [3]	Slot64	Slot63	Slot62	Slot61	Slot60	Slot59	Slot58	Slot57
Module Error [2]	Slot56	Slot55	Slot54	Slot53	Slot52	Slot51	Slot50	Slot49
Module Error [1]	Slot48	Slot47	Slot46	Slot45	Slot44	Slot43	Slot42	Slot41
Module Error [0]	Slot40	Slot39	Slot38	Slot37	Slot36	Slot35	Slot34	Slot33

Slot33: IO module ID 33; Bit set to 1 indicates polling timeout for this module

Slot34: IO module ID 34; Bit set to 1 indicates polling timeout for this module

Slot35: IO module ID 35; Bit set to 1 indicates polling timeout for this module

:

(and so on)

:

Slot64: IO module ID 64; Bit set to 1 indicates polling timeout for this module

## 7. Appendix I: i-Designer Instructions

### 7.1 Installation

Download the i-Designer program from the official website, then click on the program (as shown in the figure) to install it.



Figure 7.1 Program Icon

After reading the user agreement, please check the box and click Start Installation.



Figure 7.2 Click Start Installation

During installation, the progress will be displayed.

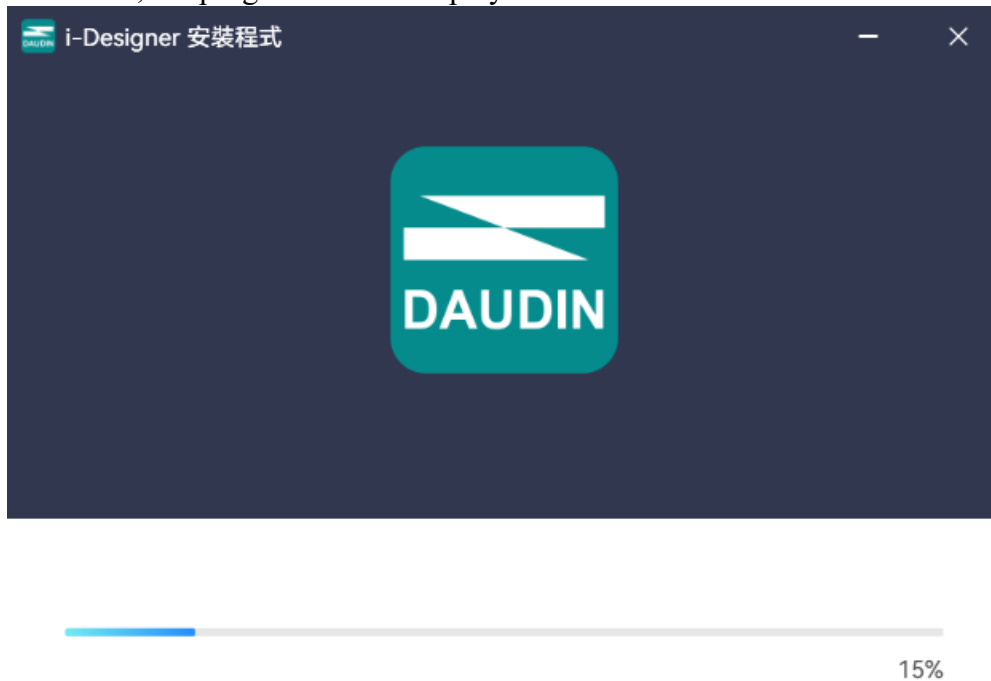

Figure 7.3 Installation Progress

Once the software installation is complete, you can choose to run it immediately by clicking the Finish button.



Figure 7.4 Installation Complete

## 7.2 UI Screen Description

After installation, locate the program icon on the desktop and click it to open the settings screen (see the figure below).



Figure 7.5 Program Icon

The screen is organized as follows, from top to bottom:

- I. Tab Area: Select different product series or switch languages.
- II. Function Key Area: Displays different function keys based on the selected tab.
- III. Display and Configuration Area: Shows the module status and settings.
- IV. Progress Display Area: Displays the progress of various functions in percentages, helping users understand the current execution status, such as configuration or updates.



Figure 7.6 Default Homepage

**Tab Area:**

- (1) Homepage Tab: Provides information about i-Designer and options for switching the language.
- (2) Product Settings Tab: Used for setting parameters for various **iO-GRID** product series.

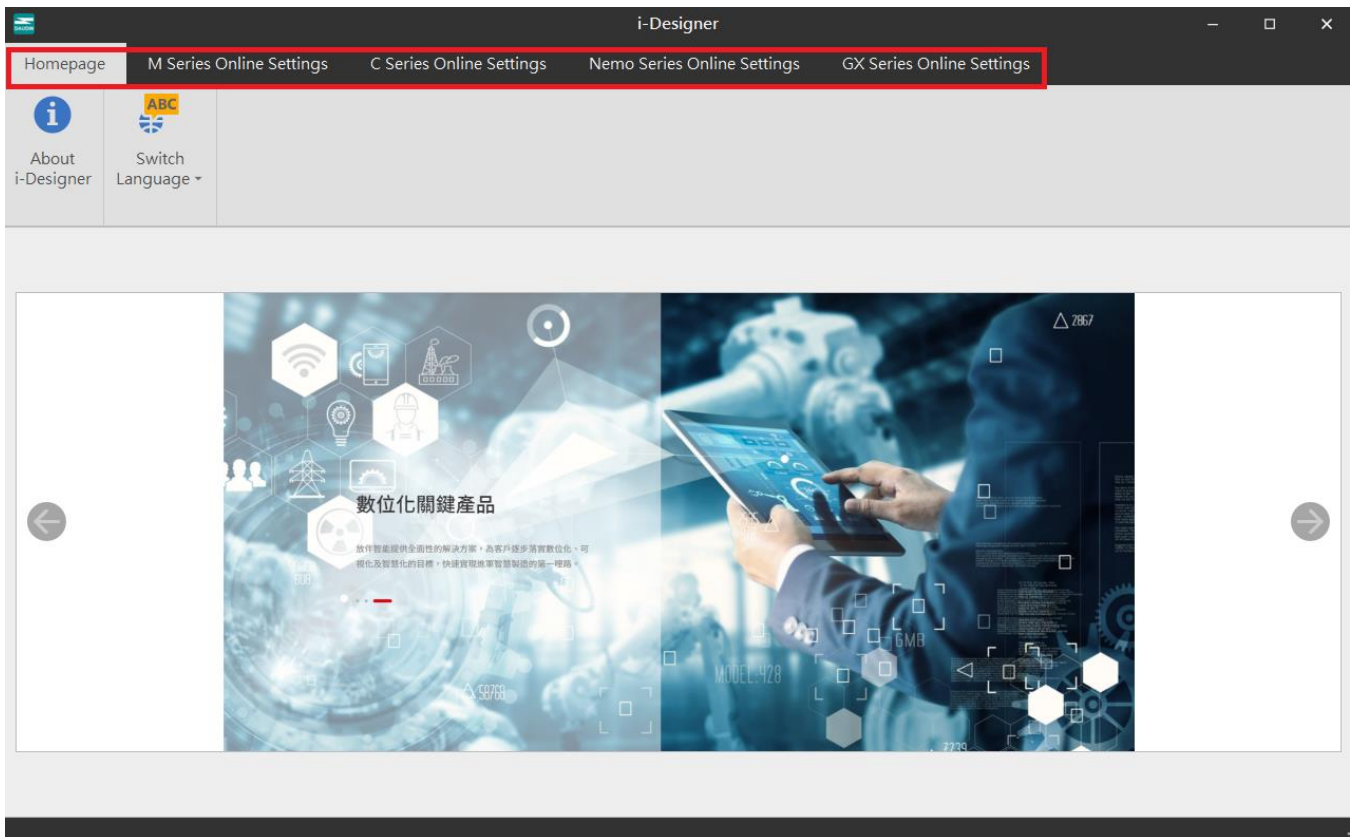















Figure 7.7 Tab

**Function Key Area:**

The function keys displayed here vary based on the selected tab and product. The relevant descriptions are as follows:

Icon	Name	Description
	About i-Designer	Shows software version information.
	Switch Languages	Switches between Traditional Chinese, Simplified Chinese, and English.
	Connection Mode	Offers automatic or manual module connection modes.
	Connection Info	
	Connect	Connects to the module.
	Disconnect	Disconnects from the module.
	System stop	Temporarily stops the module system.
	System running	Starts the module system.
	Auto Station Assignment	Reconfigures the station numbers of the module system.
	Upload parameters	Updates the module settings.
	Online Adjustment	
	Check for Updates	Searches and compares the current module firmware version to check if it's the latest.
	Firmware update	Manually updates the module firmware.
	Point Information Overview	Displays all operational data of the modules.

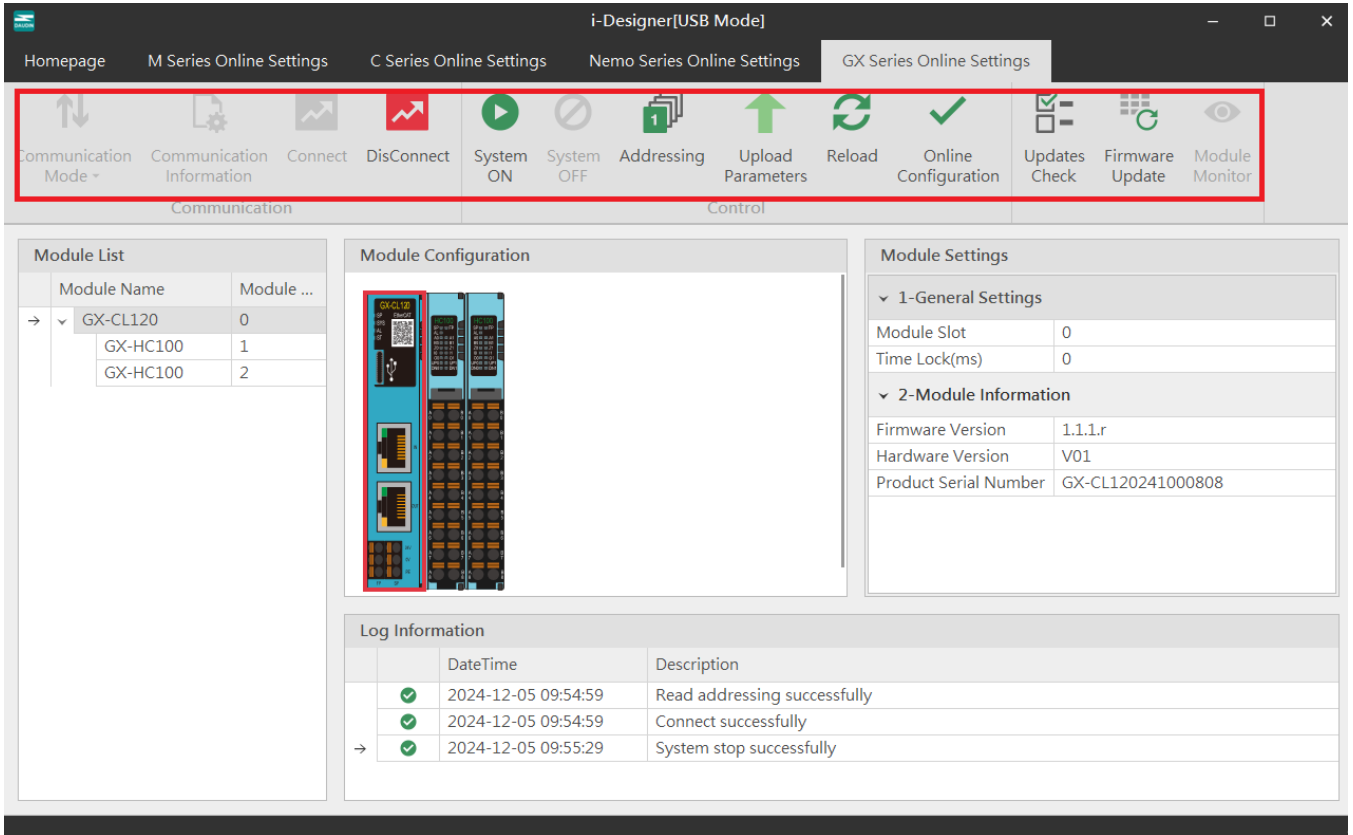

Figure 7.8 Function Key Area

**Display and Configuration Area**

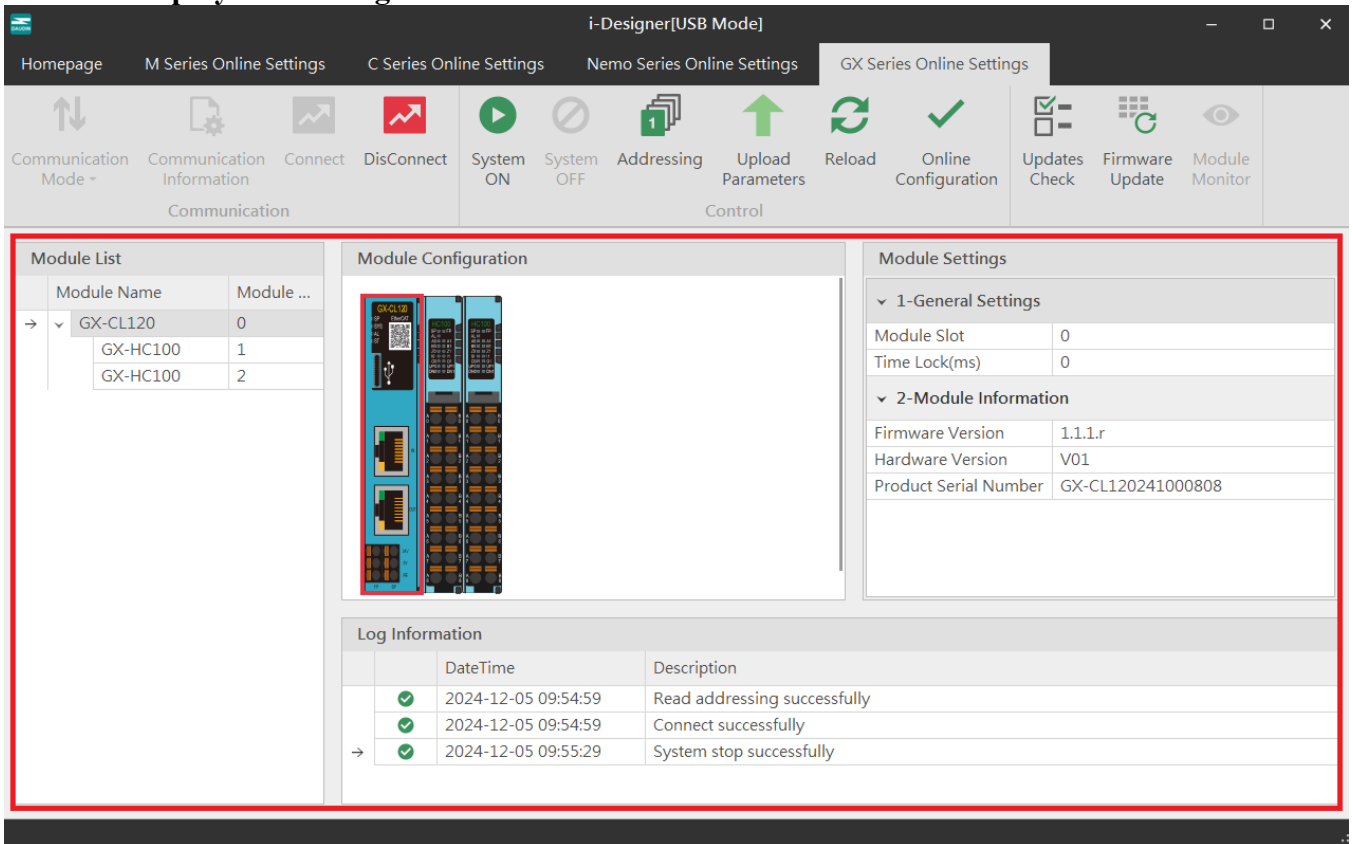

Figure 7.9 Display and Configuration Area

i-Designer[USB Mode]

Homepage M Series Online Settings C Series Online Settings Nemo Series Online Settings **GX Series Online Settings**

Communication Mode - Communication Information Communication Control

System ON System OFF Addressing Upload Parameters Reload Online Configuration Updates Check Firmware Update Module Monitor

Module List	
Module Name	Module ...
→ GX-CL120	0
GX-HC100	1
GX-HC100	2

Module Configuration **Addressing** Module Settings

1-General Settings

Module Slot 0  
Time Lock(ms) 0

2-Module Information

Firmware Version 1.1.1.r  
Hardware Version V01  
Product Serial Number GX-CL120241000808

Log Information

	DateTime	Description
✓	2024-12-05 09:54:59	Read addressing successfully
✓	2024-12-05 09:54:59	Connect successfully
✓	2024-12-05 09:55:29	System stop successfully
→ ✓	2024-12-05 09:59:31	Addressing...

Status 20%

Figure 7.10 Progress Display Area



### 7.3 i-Designer Information Verification

Click on the homepage -> About i-Designer

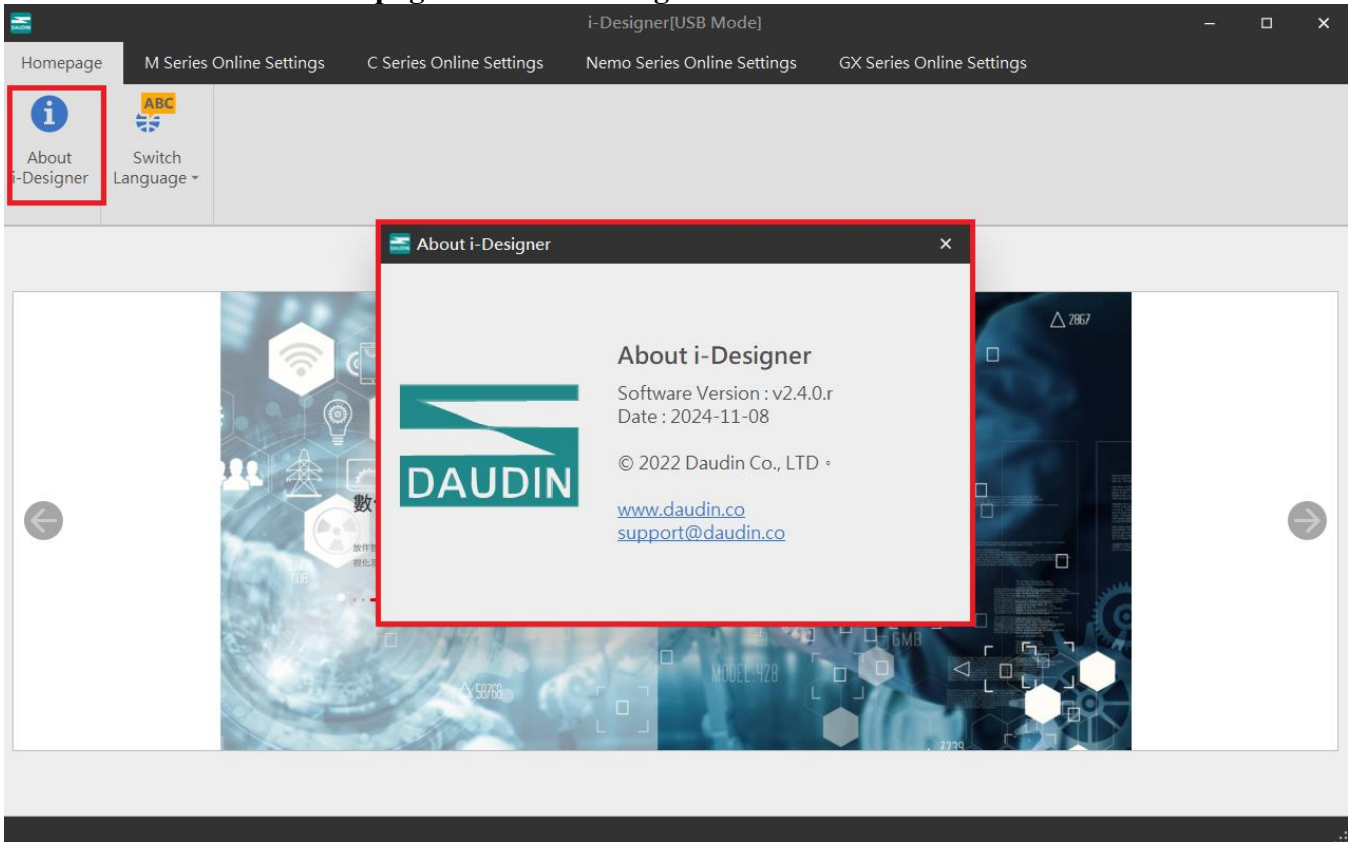

Figure 7.11 Software Information

## 7.4 Language Settings

i-Designer currently supports three languages: Traditional Chinese, Simplified Chinese, and English. Use this feature to change the language.

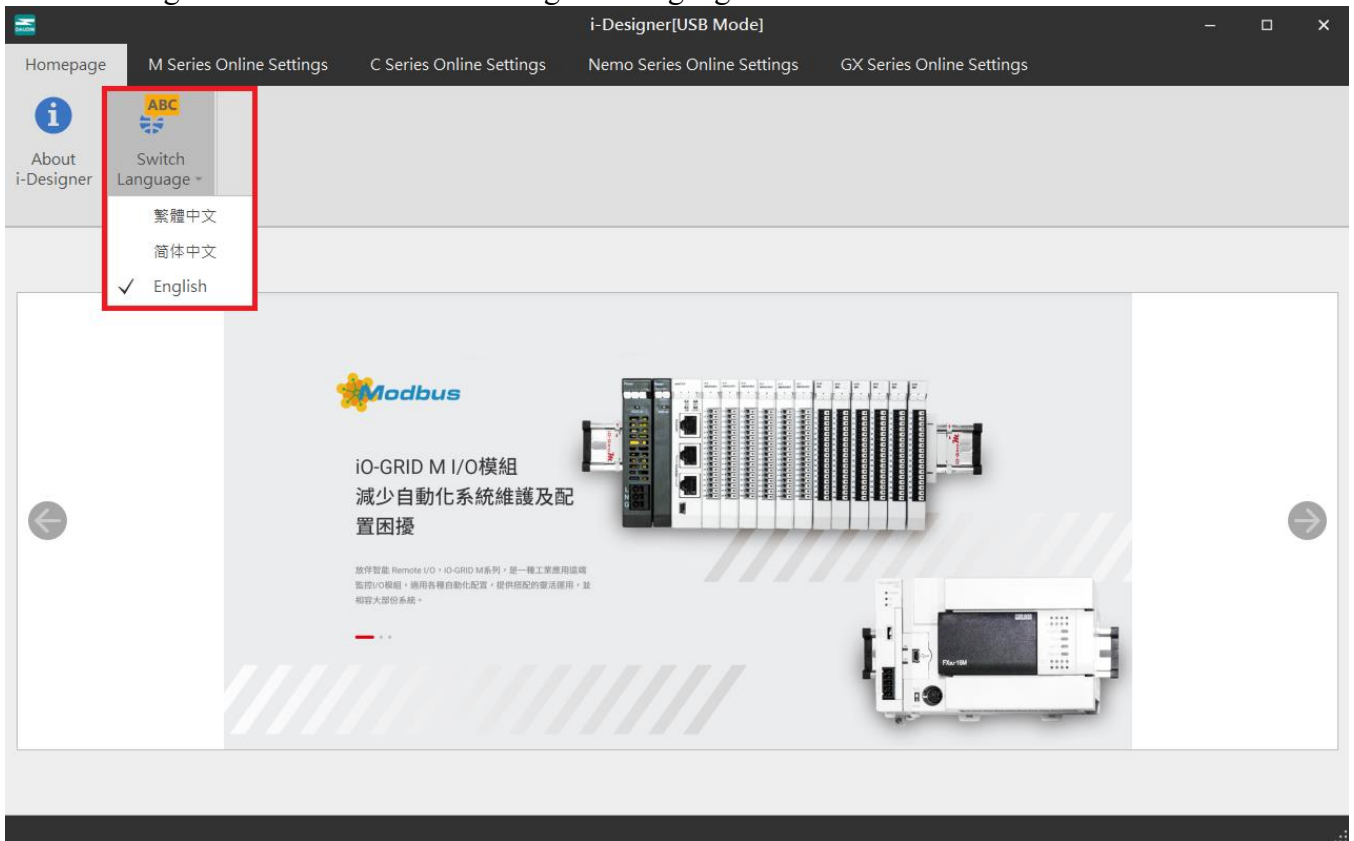

Figure 7.12 Language Selection

## 7.5 COM Port Connection Settings

i-Designer communicates with the **iO-GRID** coupler module primarily through the COM Port interface. Connection modes include automatic module search mode and manual COM Port connection mode.

Before setting up a custom connection with the **iO-GRID**, please confirm the COM Port number assigned to the coupler module to proceed with configuration.

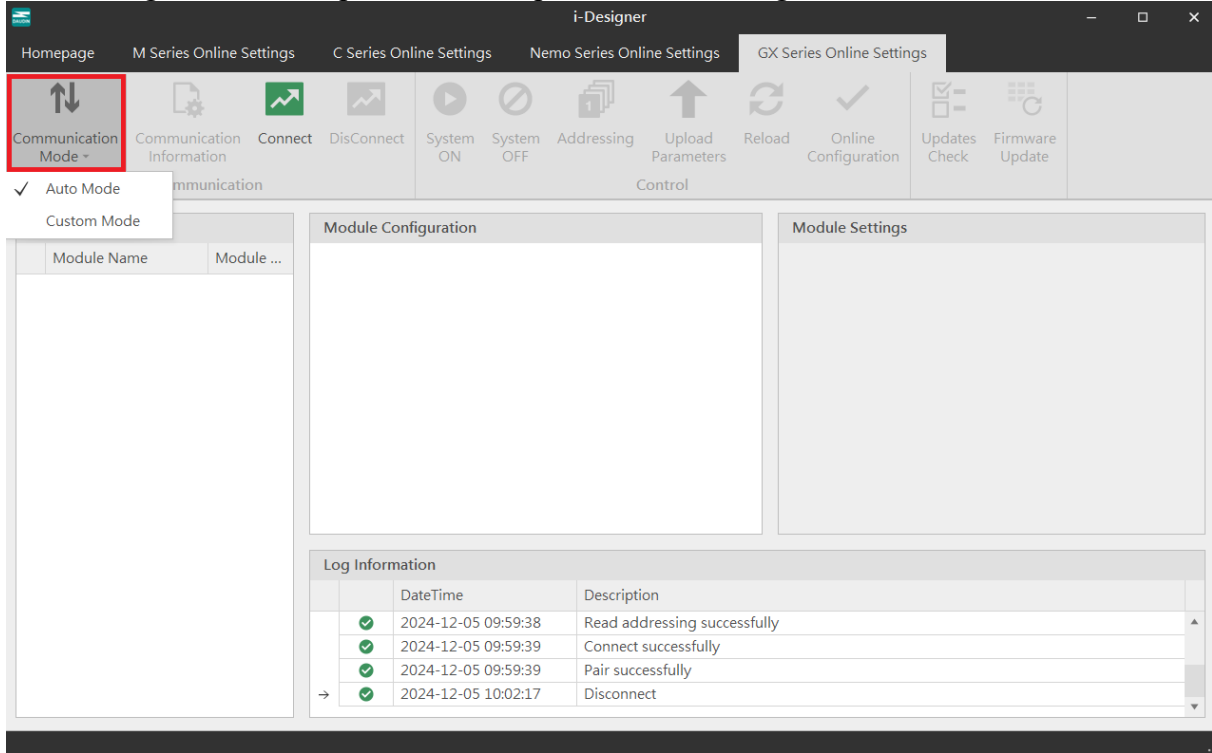

Figure 7.13 Connection Modes

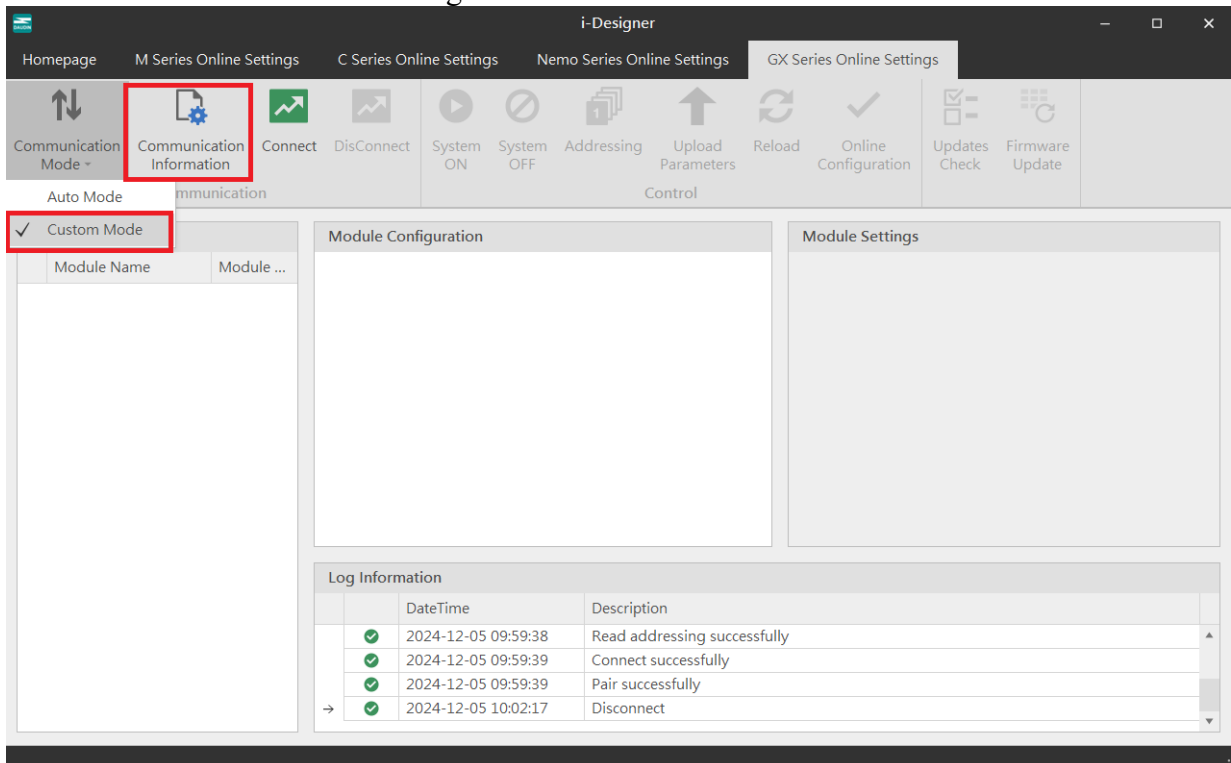

Figure 7.14 Custom Mode Setup

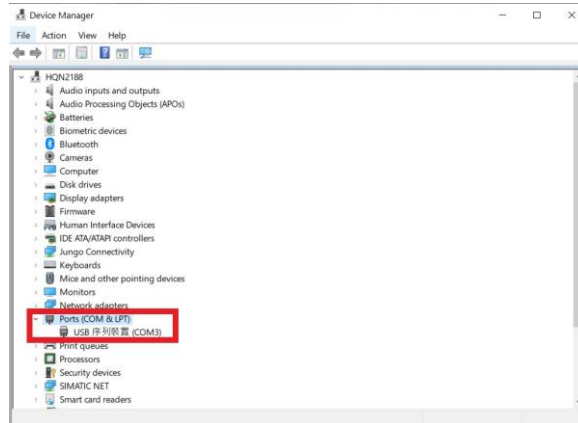

Figure 7.15 Checking the COM Port Number in Device Manager

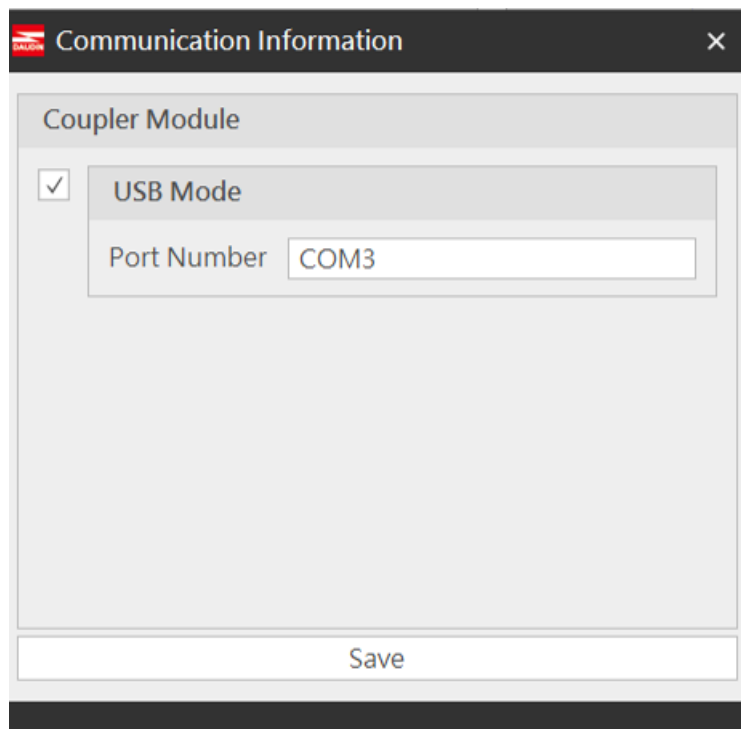

Figure 7.16 Configuring COM Port Settings

## 7.6 Connection Setting Instructions

Once the connection is successful, the current connection mode will be displayed in the window, and the firmware version of all modules will be detected. If the system is running, a pop-up window will ask whether to stop the system to perform firmware version detection for all modules.

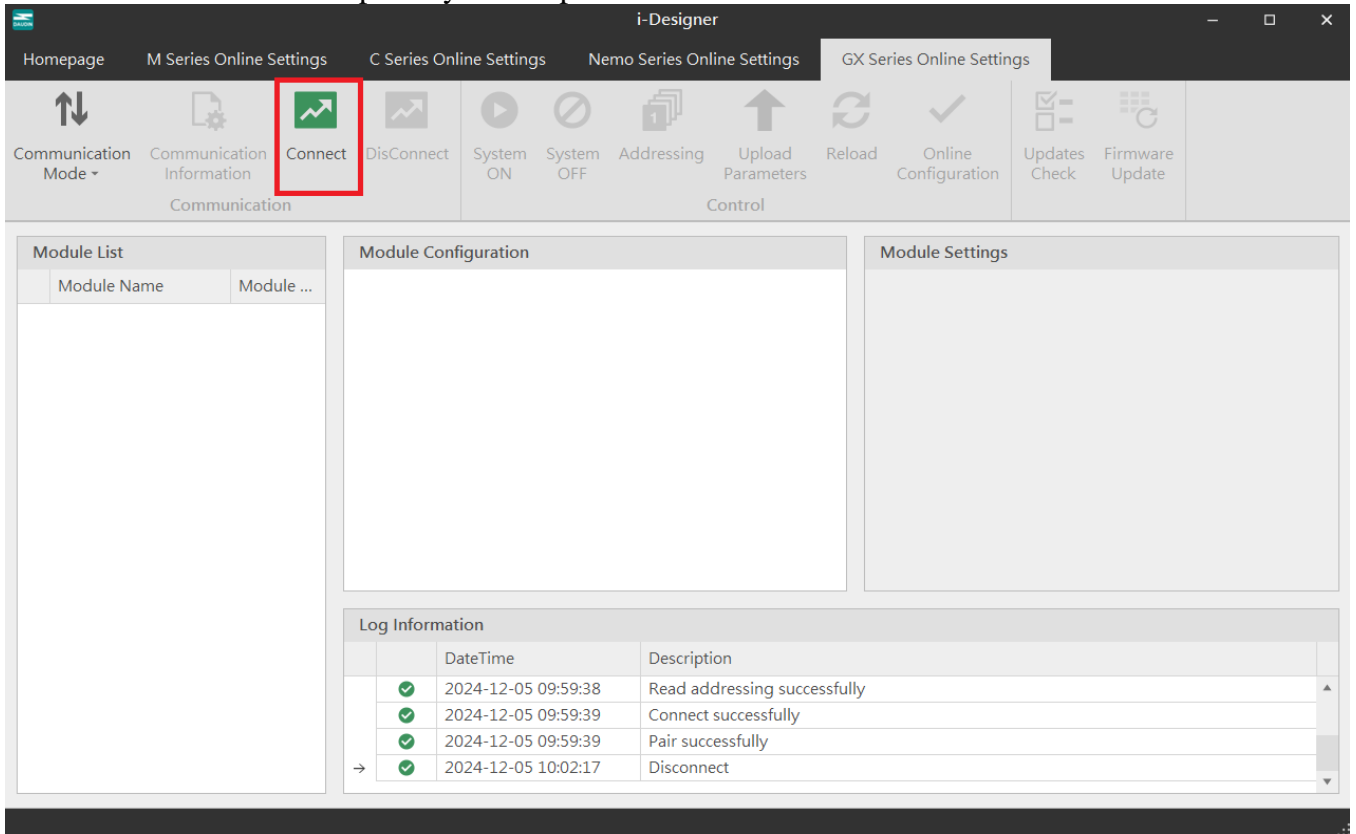

Figure 7.17 Setting Connection

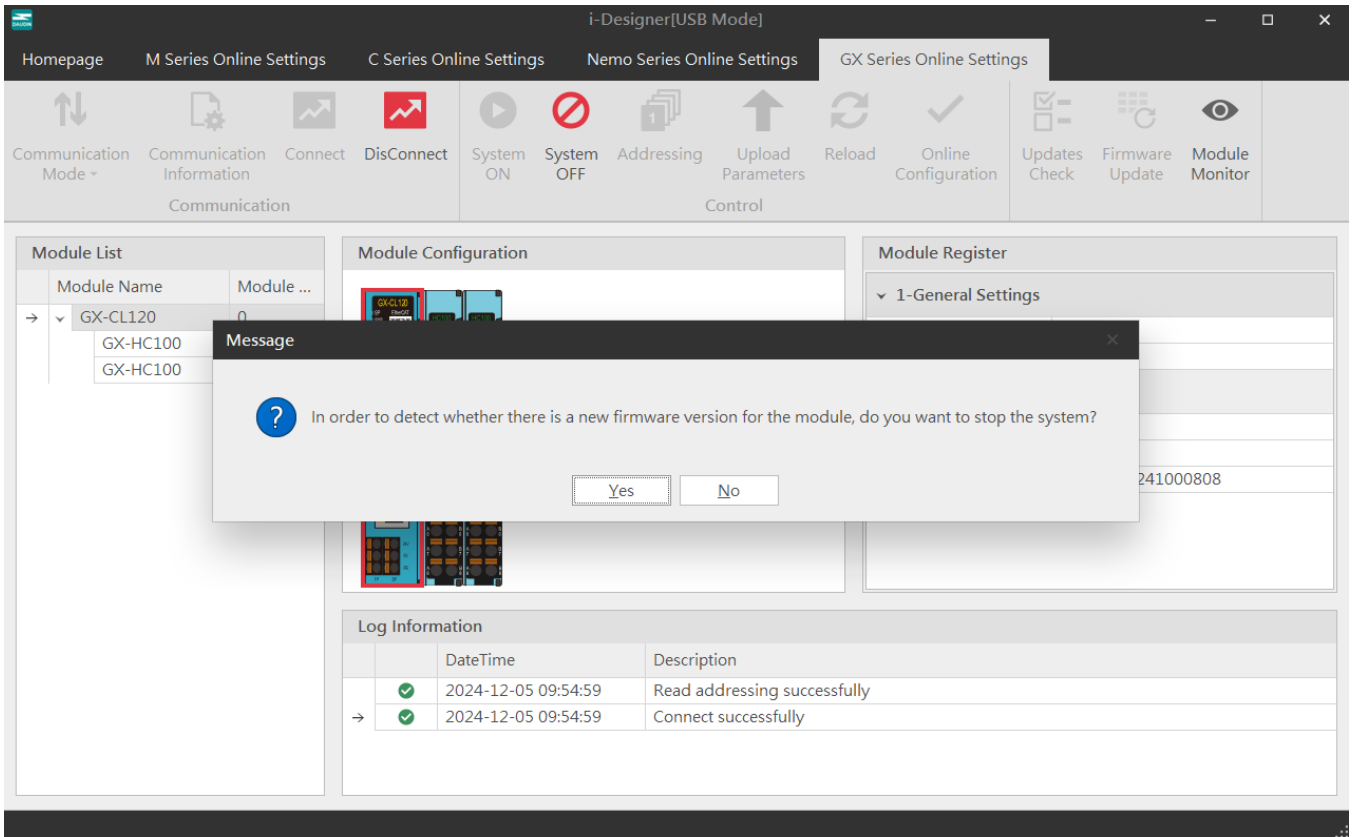

Figure 7.18 After Connection, The Module Automatically Checks For Updates And Notifies You If the system is stopped, i-Designer will automatically detect the module version.

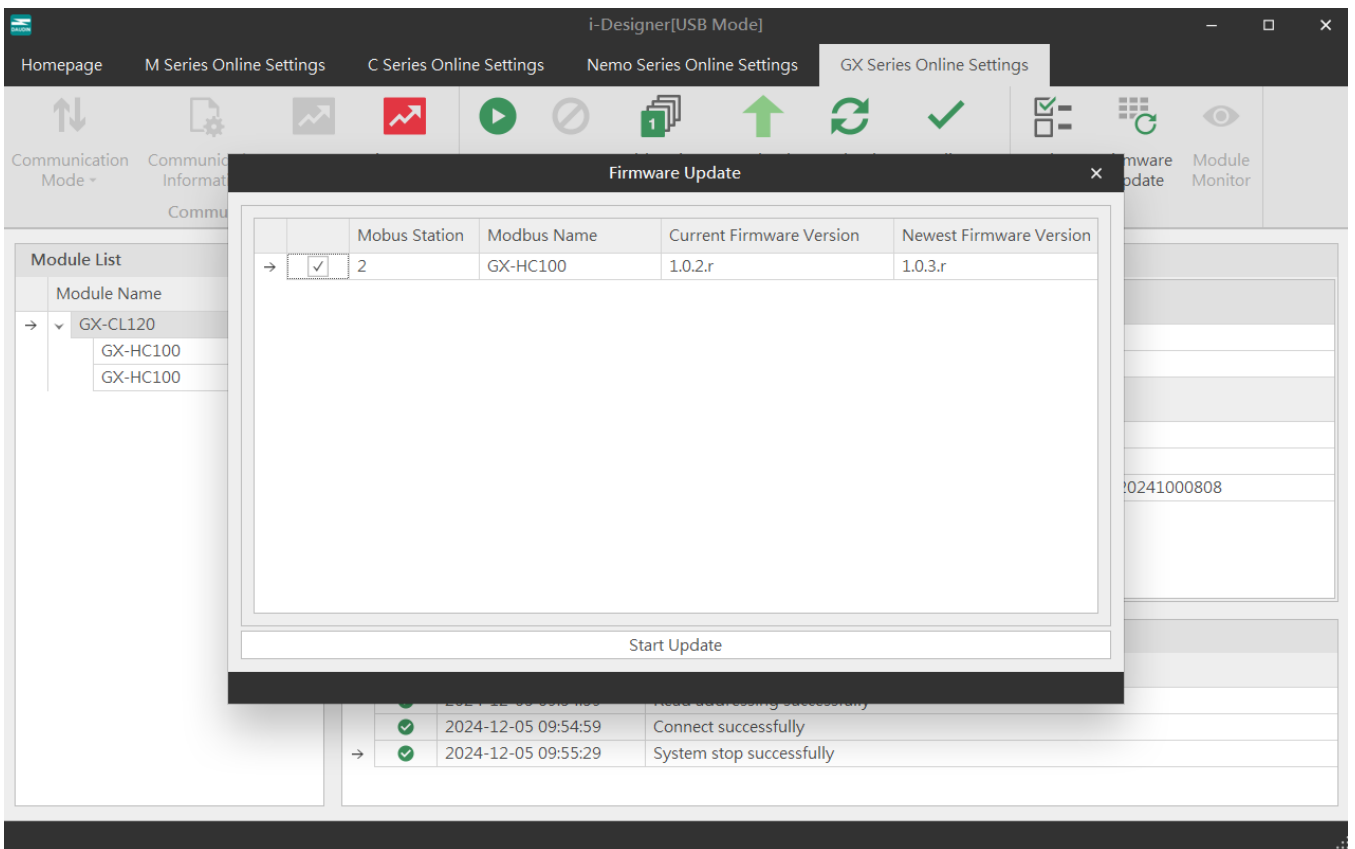

Figure 7.19 Module Version Data

Only after the system is stopped can the module functions be configured.

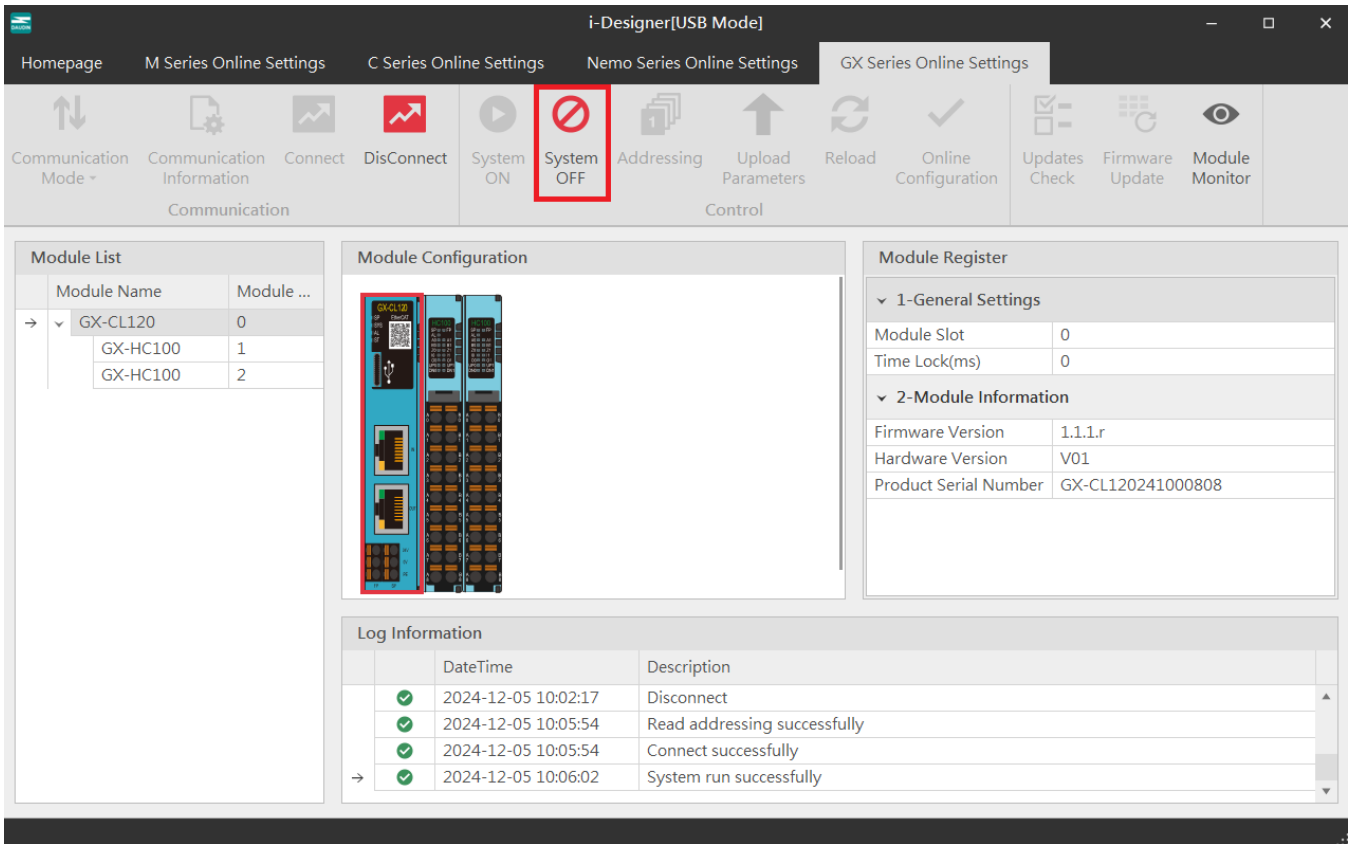

Figure 7.20 System Stop Screen

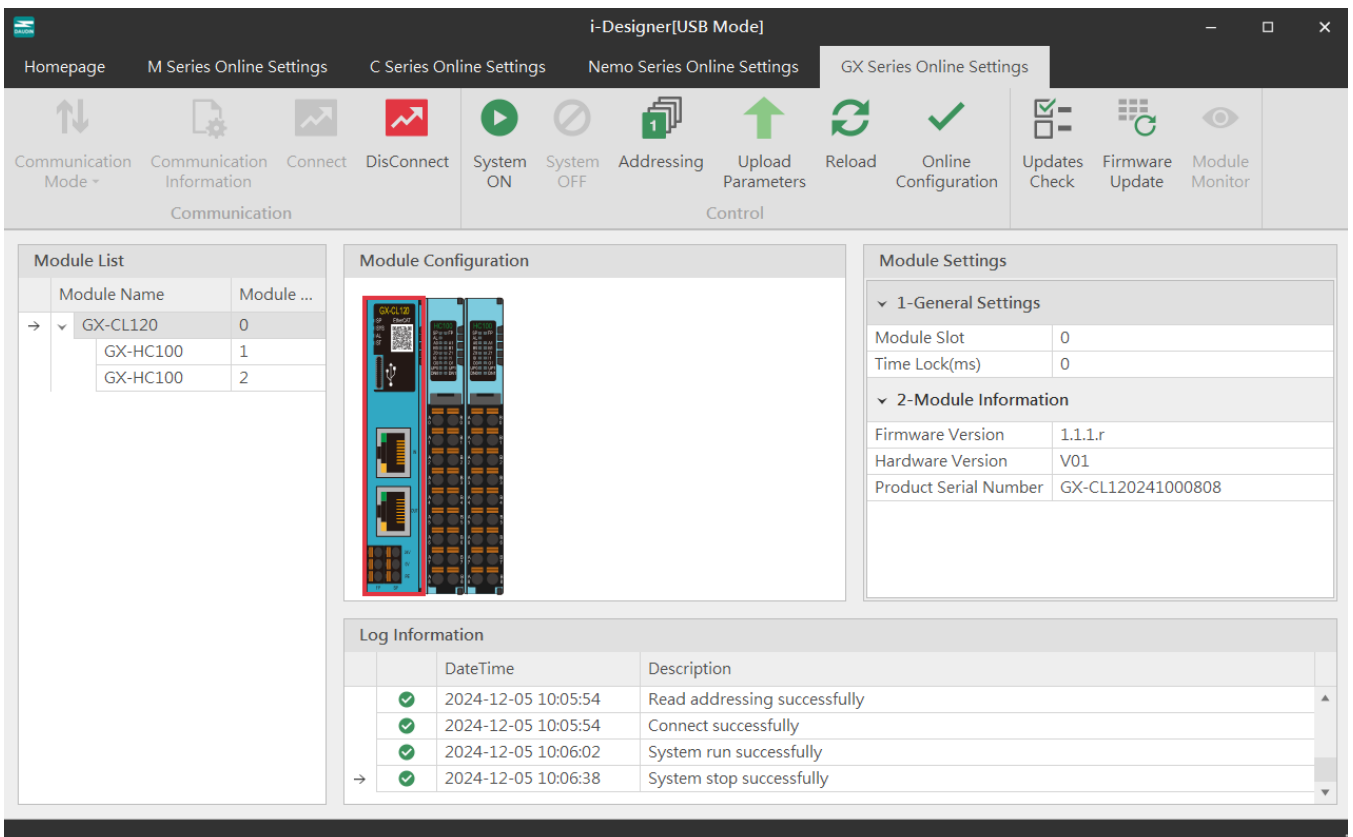
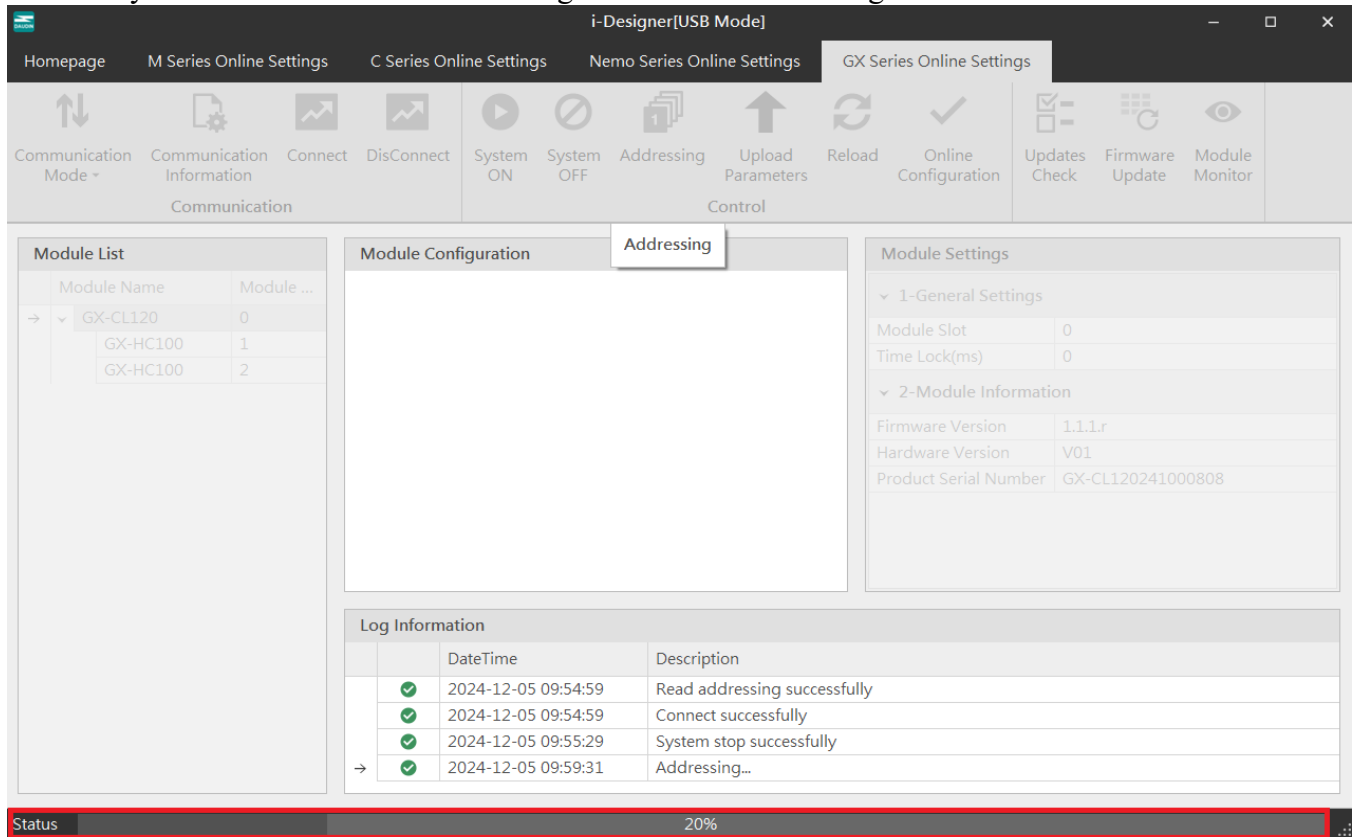

Figure 7.21 System Stop Screen

When connecting to X series modules, if the listed modules do not match the actual modules, you can search for modules through the Auto Station Assignment function.



The screenshot shows the 'i-Designer[USB Mode]' software interface. The 'GX Series Online Settings' window is active, with the 'Addressing' tab selected. The interface is divided into several sections:

- Module List:** A table listing modules with columns for 'Module Name' and 'Module ...'.
 

Module Name	Module ...
GX-CL120	0
GX-HC100	1
GX-HC100	2
- Module Configuration:** A large empty area for configuration details.
- Module Settings:** A panel with two sections:
  - 1-General Settings:**

Module Slot	0
Time Lock(ms)	0
  - 2-Module Information:**

Firmware Version	1.1.1.r
Hardware Version	V01
Product Serial Number	GX-CL120241000808
- Log Information:** A table showing system events.
 

	DateTime	Description
✓	2024-12-05 09:54:59	Read addressing successfully
✓	2024-12-05 09:54:59	Connect successfully
✓	2024-12-05 09:55:29	System stop successfully
→ ✓	2024-12-05 09:59:31	Addressing...

The bottom status bar shows 'Status' on the left and '20%' progress on the right.

Figure 7.22 Station Assignment in Progress



After configuring the module functions, you must click "Upload Parameters" to save the settings correctly.

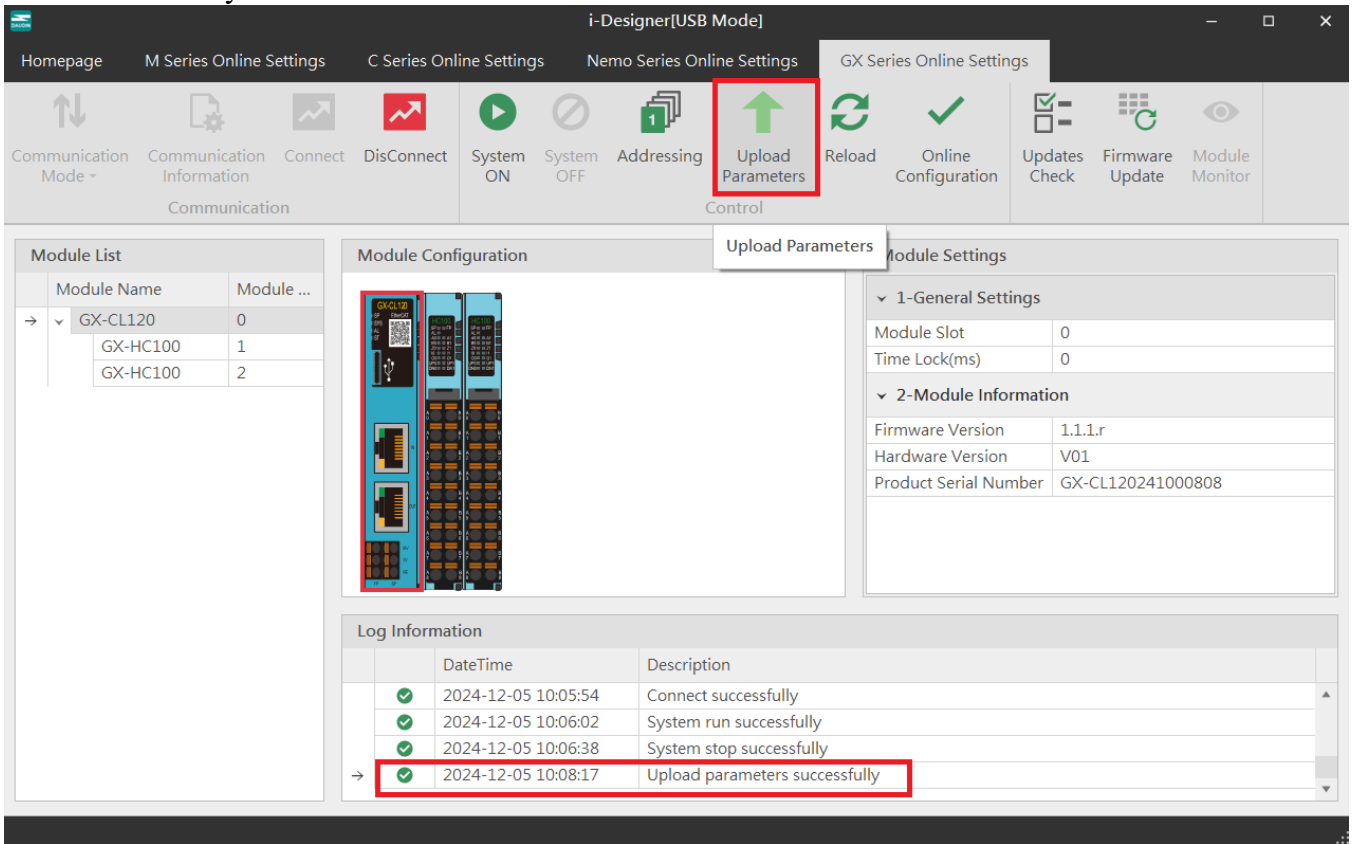

Figure 7.23 Screen After Uploading Parameters

You can view the IO point status through the online debugging feature.

**Note:** You must disconnect from the external master station before proceeding.

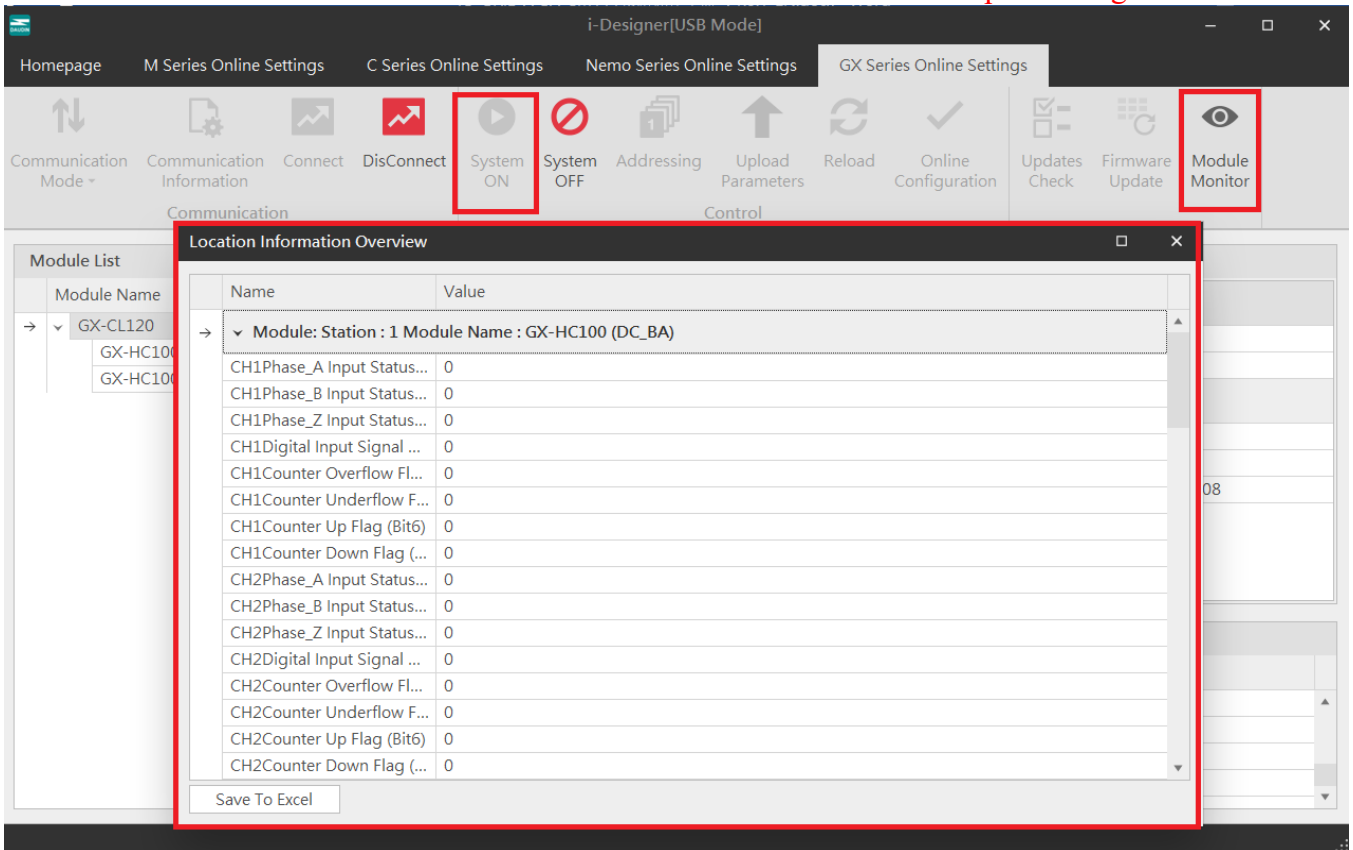

Figure 7.24 Online Adjustment Screen

The system will detect whether the current module version is the latest and prompt for updates.

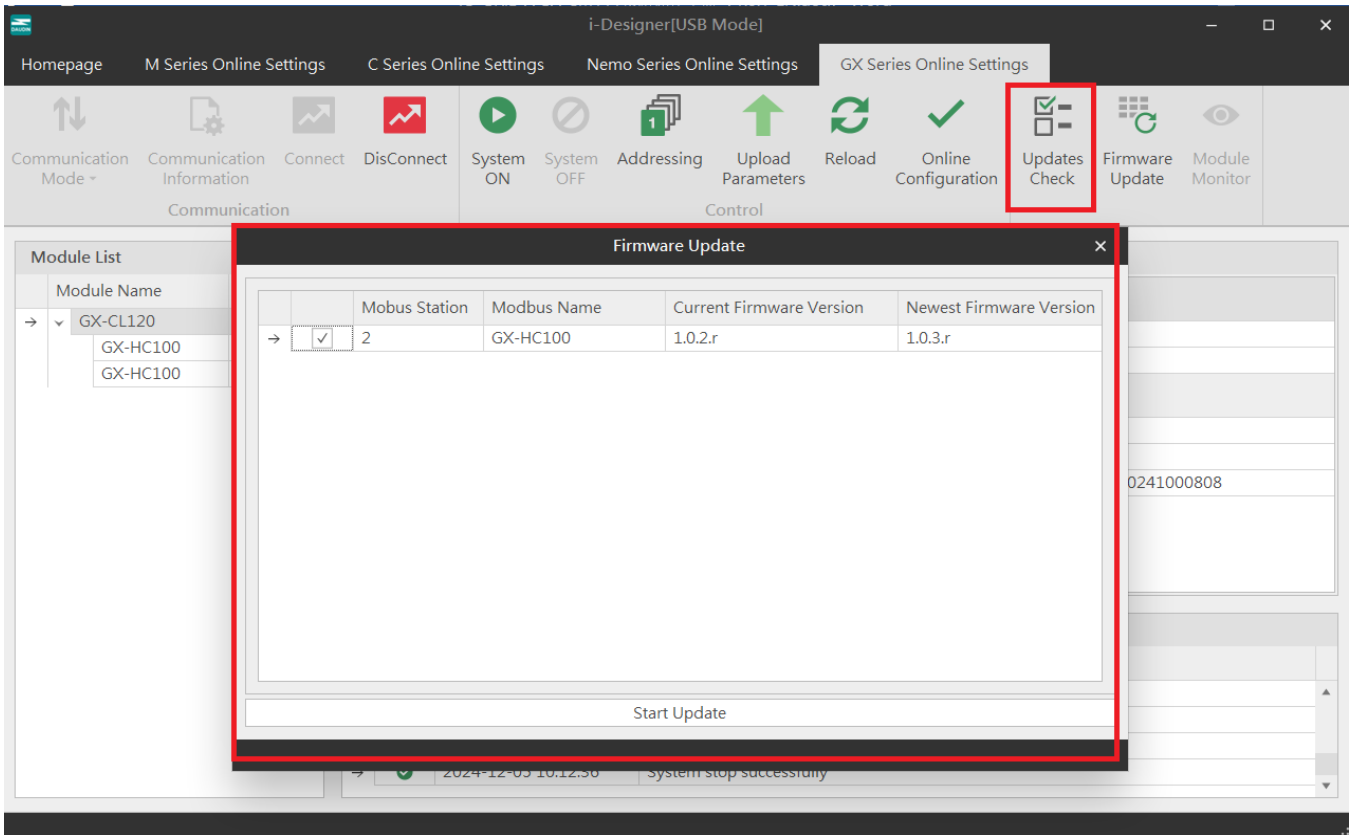

Figure 7.25 Firmware Update Screen

The GX-CL140 will display the Modbus register positions for the configured IO modules.

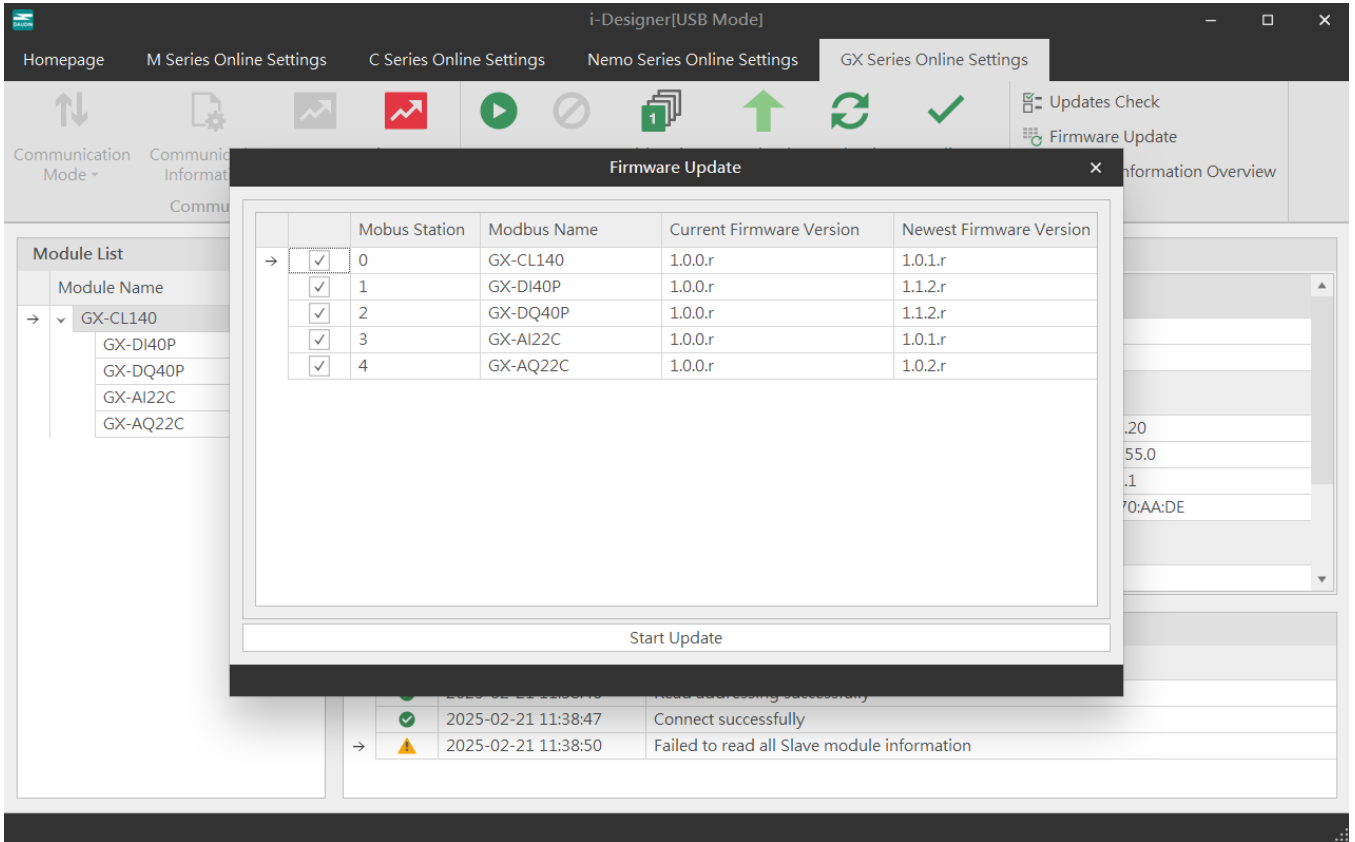
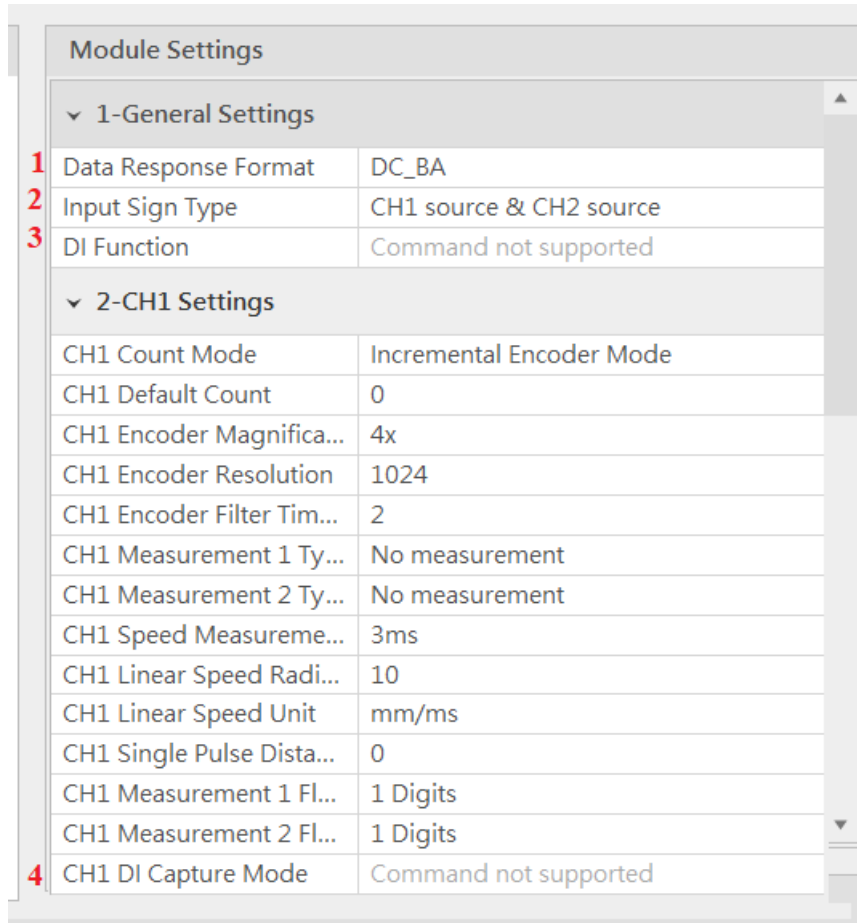

Figure 7.26 Point Information Overview Screen

## 7.7 GX-HC100 Parameter Setting Explanations



Module Settings		
▼ 1-General Settings		
1	Data Response Format	DC_BA
2	Input Sign Type	CH1 source & CH2 source
3	DI Function	Command not supported
▼ 2-CH1 Settings		
	CH1 Count Mode	Incremental Encoder Mode
	CH1 Default Count	0
	CH1 Encoder Magnifica...	4x
	CH1 Encoder Resolution	1024
	CH1 Encoder Filter Tim...	2
	CH1 Measurement 1 Ty...	No measurement
	CH1 Measurement 2 Ty...	No measurement
	CH1 Speed Measureme...	3ms
	CH1 Linear Speed Radi...	10
	CH1 Linear Speed Unit	mm/ms
	CH1 Single Pulse Dista...	0
	CH1 Measurement 1 Fl...	1 Digits
	CH1 Measurement 2 Fl...	1 Digits
4	CH1 DI Capture Mode	Command not supported

Figure 7.27

NO.	Description
1	32-bit *Data Order: DC_BA / AB_CD / CD_AB / BA_DC
2	Select signal type for A, B, Z: sink/source
3	DI function selection: Normal DI function / Pulse counting function
4	DI pulse counting mode: Rising edge / Falling edge / Both edges

\*The data order corresponds to the data transmission sequence on the host device and must match its definition for accurate readout interpretation.

Module Settings	
▼ 1-General Settings	
Data Response Format	DC_BA
Input Sign Type	CH1 source & CH2 source
DI Function	Command not supported
▼ 2-CH1 Settings	
1 CH1 Count Mode	Incremental Encoder Mode
2 CH1 Default Count	0
3 CH1 Encoder Magnifica...	4x
CH1 Encoder Resolution	1024
CH1 Encoder Filter Tim...	2
CH1 Measurement 1 Ty...	No measurement
CH1 Measurement 2 Ty...	No measurement
CH1 Speed Measureme...	3ms
CH1 Linear Speed Radi...	10
CH1 Linear Speed Unit	mm/ms
CH1 Single Pulse Dista...	0
CH1 Measurement 1 Fl...	1 Digits
CH1 Measurement 2 Fl...	1 Digits
CH1 DI Capture Mode	Command not supported

Figure 7.28.

NO.	Description
1	Each channel supports four counting modes: Encoder / Direction / Up / Down
2	Counter default value → Z-phase reset function When Z-phase reset is triggered and DataInOut is swapped, “Set default value for counter CHx” is used; without DataInOut swap, this setting is applied.
3	Relevant settings for Encoder Mode Multiplier setting: x1 / x2 / x4 Resolution range: 1~65535 Filter time: MCU-side filtering level for signals A and B, with higher values indicating longer filtering intervals Filter time is frequency-dependent; long filtering times should be avoided for higher frequencies

Module Settings	
<ul style="list-style-type: none"> <li>1-General Settings</li> </ul>	
Data Response Format	DC_BA
Input Sign Type	CH1 source & CH2 source
DI Function	Command not supported
<ul style="list-style-type: none"> <li>2-CH1 Settings</li> </ul>	
CH1 Count Mode	Incremental Encoder Mode
CH1 Default Count	0
CH1 Encoder Magnifica...	4x
CH1 Encoder Resolution	1024
CH1 Encoder Filter Tim...	2
CH1 Measurement 1 Ty...	No measurement
CH1 Measurement 2 Ty...	No measurement
CH1 Speed Measureme...	3ms
CH1 Linear Speed Radi...	10
CH1 Linear Speed Unit	mm/ms
CH1 Single Pulse Dista...	0
CH1 Measurement 1 Fl...	1 Digits
CH1 Measurement 2 Fl...	1 Digits
CH1 DI Capture Mode	Command not supported

Figure 7.29.

Each channel can select between two measurement types:

Rotation speed, frequency, angular velocity, linear velocity, cumulative position, cumulative pulse count.

An update interval (sampling period) can be selected for each channel measurement:

- Options: 3/10/20/50/100/200/500/1000/2000 ms

- Sampling period is frequency-dependent; lower frequencies are unsuitable for shorter sampling periods.

Linear velocity units: For high linear velocity measurement, it is recommended to use m/min to avoid int32 overflow.

Floating Point Precision:

- Options: 1/2/3/4 decimal places

- For example, for 1.56789, the different precision settings are shown as:

Floating Point Precision	1 decimal place	2	3	4
Data Shown as	15	156	1567	15678

## 7.8 Operation Parameter Definitions

Input Data								
Bit No	Bit7	Bit6	Bit5	Bit4	Bit3	Bit2	Bit1	Bit0
Byte 0	Counter Down CH1	Counter Up CH1	Counter underflow CH1	Counter overflow CH1	DI CH1	Z CH1	B CH1	A CH1
Byte 1	Reserved							
Byte 2	Counter Down CH2	Counter Up CH2	Counter underflow CH2	Counter overflow CH2	DI CH2	Z CH2	B CH2	A CH2
Byte 3	Reserved							
Byte 4	Counter value CH1							
Byte 5								
Byte 6								
Byte 7								
Byte 8	Capture value CH1							
Byte 9								
Byte 10								
Byte 11								
Byte 12	Measurement 1 CH1							
Byte 13								
Byte 14								
Byte 15								
Byte 16	Measurement 2 CH1							
Byte 17								
Byte 18								
Byte 19								
Byte 20	Counter value CH2							
Byte 21								
Byte 22								
Byte 23								
Byte 24	Capture value CH2							
Byte 25								
Byte 26								
Byte 27								
Byte 28	Measurement 1 CH2							





Byte 29	Measurement 2 CH2
Byte 30	
Byte 31	
Byte 32	
Byte 33	
Byte 34	
Byte 35	

### Value Definition

A/B/Z CH#	Signal Validity	1: Valid 0: Invalid
DI CH#	Digital Input Signal State	1: Valid 0: Invalid
Counter overflow CH#	Counter Overflow Flag (overflow flag triggered by the counter's up-count operation)	0: No overflow 1: overflow
Counter underflow CH#	Counter Underflow Flag (overflow flag triggered by the counter's down-count operation)	0: No overflow 1: overflow
Counter Up CH#	Counter Up Count Flag: Indicates that the counter is in up-count mode.	1: Up-counting
Counter Down CH#	Counter Down Count Flag: Indicates that the counter is in down-count mode.	1: Down-counting
Counter value CH#	Channel CH# Count Value, int32 type	
Capture value CH#	Pulse Count Value, int32 type. Pulse count captured when DI is set to capture function.	
Measurement1 CH#	First Set of Measurements for Channel CH#, int32 type.	
	Measurement Type	Unit
	Measurement Speed (rpm) Supports 1/2/3/4 decimal places as per settings	rpm
	Frequency Measurement	Hz
	Angular Velocity Supports 1/2/3/4 decimal places as per settings	deg/ms
	Linear Velocity Supports 1/2/3/4 decimal places as per settings	mm/ms, mm/sec, m/min
	Actual Position Supports 1/2/3/4 decimal places as per settings	mm
	Cumulative Pulse Count	
Measurement2 CH#	Second Set of Measurements for Channel CH#, int32 type.	
	Measurement Type	Unit
	Measurement Speed (rpm) Supports 1/2/3/4 decimal places as per settings	rpm
	Frequency Measurement	Hz
	Angular Velocity Supports 1/2/3/4 decimal places as per settings	deg/ms
	Linear Velocity Supports 1/2/3/4 decimal places as per settings	mm/ms, mm/sec, m/min
	Actual Position Supports 1/2/3/4 decimal places as per settings	mm
	Cumulative Pulse Count	



Output Data								
Bit No	Bit7	Bit6	Bit5	Bit4	Bit3	Bit2	Bit1	Bit0
Byte 0	Reserved				DO CH1	Position Clear CH1	Flow Clear CH1	Counter reset CH1
Byte 1	Reserved							
Byte 2	Reserved				DO CH2	Position Clear CH2	Flow Clear CH2	Counter reset CH2
Byte 3	Reserved							
Byte 4	Set default value for counter CH1							
Byte 5								
Byte 6								
Byte 7								
Byte 8	Set default value for counter CH2							
Byte 9								
Byte 10								
Byte 11								
Byte 12	Set default pulse number for CH1							
Byte 13								
Byte 14								
Byte 15								
Byte 16	Set default pulse number for CH2							
Byte 17								
Byte 18								
Byte 19								



Value Definition

Counter reset CH#	When 0 → 1, the counter value will be updated to the default value.
Flow Clear CH#	When 0 → 1, the overflow and underflow flags for CH# will be cleared.
Position Clear CH#	When 0 → 1, the "Actual Position" and "Cumulative Pulse Count" will be reset to their default values.
DO CH#	Digital output channel control
default value for CH#	Set the default counter value for CH#, using an int32 data type.
default pulse num for CH#	Set the default cumulative pulse count value for CH#, using an int32 data type.

## 7.9 Special Module Function Settings

GX-HC100 parameter settings

can be set using DAUDIN i-Designer. Follow the steps below:

- Connect the Coupler to the USB cable and power up the system after configuring it with the GX-HC100.
- Open i-Designer, select the GX Series Online Setup page, and click [Connect].

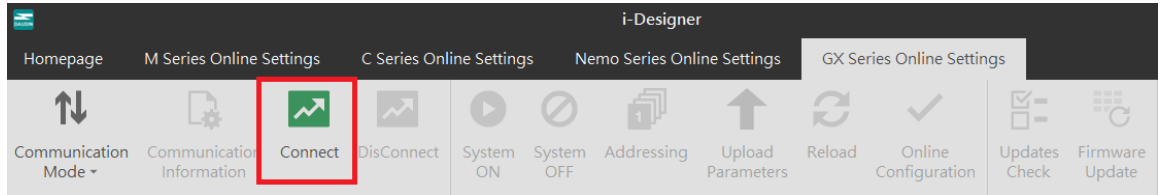

Figure 7.30.

- Select the GX-HC100 module and click [System Stop].

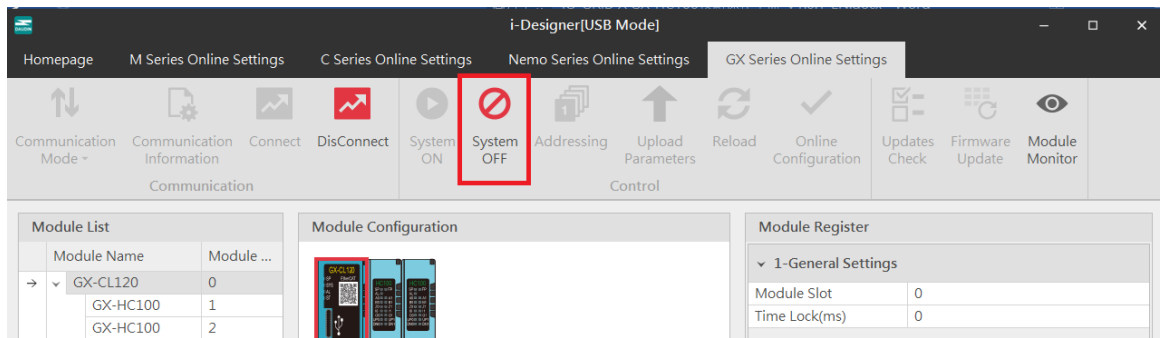

Figure 7.31.

- Click [GX-HC100] in the module list. The parameters for each channel and the module version information will be displayed in the right panel. You can set the parameters for each channel based on the encoder characteristics and usage requirements. After completing the settings, click [Upload Parameters].

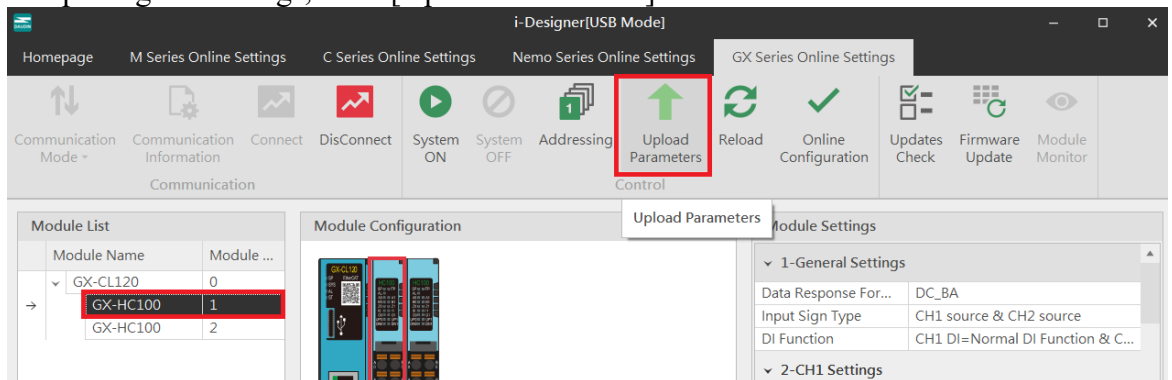

Figure 7.32.

- The result of the parameter upload will be displayed in the log information at the bottom of the window.

Log Information			
		DateTime	Description
	✓	2024-11-25 14:05:39	Disconnect
	✓	2024-11-25 14:06:32	Read addressing successfully
	✓	2024-11-25 14:06:32	Connect successfully
	⚠	2024-11-25 14:06:36	Failed to read all Slave module information
	✓	2024-11-25 14:06:40	System run successfully
	✓	2024-11-25 14:07:35	System stop successfully
→	✓	2024-11-25 14:08:36	Upload parameters successfully

Figure 7.33.

- The descriptions of the GX-HC100 module parameters are as follows:

Module Parameter Settings	Data Type	Parameter Definition	Default Value
[Channel# Counting Mode]	uint8	0: Incremental Encoder Mode 1: Count Direction Mode 2: Up Mode 3: Down Mode	0
[Channel# Counter Default Value] The Z-phase reset will reset the counter value to this default.	int32	Default counter value Valid range: 0 ~ (Resolution * Multiplier)	0
[Channel# Encoder Multiplier] Encoder frequency setting for Incremental Encoder Mode.	uint8	Encoder multiplier: 0: 1x multiplier 1: 2x multiplier 2: 4x multiplier (Only valid in Incremental Encoder Mode)	2
[Channel# Encoder Resolution]	uint16	Encoder resolution (the number of pulses per encoder revolution). Valid range: 1~ 65535 (Only valid in Incremental Encoder Mode)	1024
[Channel# Encoder Filtering Time]	uint8	Filtering time: 0: No filtering 1 ~ 15: Signal A and B filtering levels. The higher the number, the longer the filtering time.	2
[Channel# Measurement 1 Type]	uint8	First measurement type: 0: No measurement 1: Speed (rpm) 2: Frequency (Hz) 3: Angular velocity (deg/ms) 4: Linear velocity (mm/ms, mm/sec, m/min) 5: Actual position (mm) 6: Cumulative Pulse Count	0
[Channel# Measurement 2 Type]	uint8	Second measurement type: 0: No measurement 1: Speed (rpm) 2: Frequency (Hz) 3: Angular velocity (deg/ms) 4: Linear velocity (mm/ms, mm/sec, m/min) 5: Actual position (mm) 6: Cumulative Pulse Count	0
[Channel# Speed Measurement Update Interval]	uint8	Sampling period for measurements: 0: 3ms 1: 10ms 2: 20ms 3: 50ms	0

		4: 100ms 5: 200ms 6: 500ms 7: 1000ms 8: 2000ms It is recommended to choose an appropriate sampling interval based on the frequency.	
[Channel# Linear Velocity Radius (mm)]	uint16	Linear velocity radius (mm) 0: Invalid setting (linear velocity is 0) Valid range: 1~65535	10
[Channel# Linear Velocity Unit]	uint8	Linear velocity unit: 0: Invalid setting (linear velocity is 0) 1: mm/ms 2: mm/s 3: m/min	1
[Channel# Single Pulse Distance (mm)]	float	The distance represented by a single pulse used to calculate the actual position; supports floating-point values. Example: 0.001 represents 0.001 mm/pulse	0
[Channel# Measurement 1 Floating Point Precision]	uint8	Supported measurement types: Floating-point precision for speed (rpm), angular velocity, linear velocity, and actual position 1: 1 decimal place 2: 2 decimal place 3: 3 decimal place 4: 4 decimal place	1
[Channel# Measurement 2 Floating Point Precision]	uint8	Supported measurement types: Floating-point precision for speed (rpm), angular velocity, linear velocity, and actual position 1: 1 decimal place 2: 2 decimal place 3: 3 decimal place 4: 4 decimal place	1
[Channel Input Type]	uint8	Set the input type for signals A, B, and Z for CH1 and CH2: 0: CH1 source & CH2 source 0: CH1 sink & CH2 source 0: CH1 source & CH2 sink 0: CH1 sink & CH2 sink	0
[Channel DI Function]	uint8	0: CH1 DI = Normal DI function & CH2 DI = Normal DI function 1: CH1 DI = Pulse counting function & CH2 DI = Normal DI function 2: CH1 DI = Normal DI function & CH2 DI = Pulse counting function 3: CH1 DI = Pulse counting function & CH2 DI = Pulse counting function	0





[Channel# DI Pulse Counting Mode]	uint8	0: Rising edge trigger to count DI pulses 1: Falling edge trigger to count DI pulses 2: Both edges trigger to count DI pulses	0
-----------------------------------	-------	---	---