



iO-GRID X Series

GX-RT200

Module User Manual



Table of Contents

1.	Introduction.....	3
2.	Product Features	3
2.	Module Specifications	6
2.1	Electrical Specifications	6
2.2	General Specifications	7
2.3	Temperature Module Specifications.....	8
3.	Temperature Module Panel Overview.....	9
4.	Module Installation and Removal Instructions.....	10
4.1	Installation.....	10
4.2	Removal.....	11
4.3	Module Dimensions.....	12
5.	Module Wiring Instructions.....	13
5.1	GX-RT200.....	13
6.	Parameter Setting and Configuration Instructions	14
6.1	Product Assembly Configuration.....	14
6.2	Coupler Parameter Description	15
6.3	Factory Defaults.....	17
6.4	Error Code Lookup.....	18
6.5	Temperature Module Parameters	20
7.	Appendix I: i-Designer Instructions	22
7.1	Installation.....	22
7.2	UI Screen Description.....	24
7.3	i-Designer Information Verification	29
7.4	Language Settings	30
7.5	COM Port Connection Settings	31
7.6	Connection Setting Instructions	33

1. Introduction

The GX-RT200 is a plug-in temperature control module that supports RTD (resistance temperature detector) sensors. When used with GX series connector modules, it can collect real-time temperature data and achieve precise temperature control.

2. Product Features

- **Versatile Measurement Types**

Supports a variety of sensor types.

- **High Sensitivity**

Sensitivity level of 0.1°C.

- **Compact and Easy to Install**

Compact design with minimal space requirements, DIN 35 mm standard rail mounting, and plug-in terminals for fast, easy wiring.

- **Easy Diagnostics**

Innovative channel indicator light design for easy, quick inspection and troubleshooting.

- **Multi-Protocol Support**

Simplified system configuration, supporting standard industrial communication protocols including PROFINET, EtherCAT, EtherNet/IP, and ModbusTCP when used with a coupler.

**Caution (ATTENTION):**

1. THIS DEVICE IS FOR INDOOR USE ONLY, DON'T PUT OR USE IT IN HIGH TEMPERATURE AND HIGH MOISTURE ENVIRONMENT.

CET EQUIPEMENT EST DESTINE A UN USAGE INTERIEUR UNIQUEMENT NE PAS STOCKER OU UTILISER DANS UN ENVIRONNEMENT A HAUTE TEMPERATURE ET HAUTE HUMIDITE.

2. AVOID FALLING AND BUMPING OTHERWISE THE ELECTRICAL COMPONENTS WILL BE DAMAGED.

ÉVITEZ DE TOMBER ET DE VOUS ÉCRASER, SINON LES COMPOSANTS ÉLECTRIQUES SERONT ENDOMMAGÉS

3. DON'T TRY TO DISASSEMBLE OR OPEN THE COVER UNDER ANY CIRCUMSTANCE IN ORDER TO AVOID DANGER.

NE TENTEZ JAMAIS DE DEBALLER OU D'OUVRIR LE COUVERCLE POUR EVITER TOUT DANGER.

4. IF THE EQUIPMENT IS USED IN A MANNER NOT SPECIFIED BY THE MANUFACTURER, THE PROTECTION PROVIDED BY THE EQUIPMENT MAY BE IMPAIRED.

SI L'APPAREIL N'EST PAS UTILISE DE LA MANIERE INDIQUEE PAR LE FABRICANT, LA PROTECTION FOURNIE PAR L'APPAREIL PEUT ETRE ALTEREE.

5. THE INSTALLATION THAT THE SAFETY OF ANY SYSTEM INCORPORATING THE EQUIPMENT IS THE RESPONSIBILITY OF THE ASSEMBLER OF THE SYSTEM.

L'INSTALLATION DE TOUT SYSTÈME INTÉGRANT CET ÉQUIPEMENT EST LA RESPONSABILITÉ DU CONSTRUCTEUR DU SYSTÈME.

6. USE WITH COPPER CONDUCTORS ONLY. INPUT WIRING: MINIMUM 28 AWG, 85°C, OUTPUT WIRING: MINIMUM 28 AWG, 85°C

DESTINÉ À ÊTRE UTILISÉ AVEC DES CONDUCTEURS EN CUIVRE SEULEMENT. CABLAGE D'ENTREE: MINIMUM 28 AWG, 85 ° C. CABLAGE DE SORTIE: MINIMUM 28 AWG, 85 ° C.

7. FOR USE IN A CONTROLLED ENVIRONMENT. REFER TO MANUAL FOR ENVIRONMENTAL CONDITIONS.

POUR UN ENVIRONNEMENT CONTROLE. REPORTEZ-VOUS AU MANUEL DES CONDITIONS ENVIRONNEMENTALES.

8. DISCONNECT ALL SOURCES OF SUPPLY BEFORE SERVICING.

COUPER TOUTES LES SOURCES D'ALIMENTATION AVANT DE FAIRE L'ENTRETIEN ET LES RÉPARATIONS.

9. PROPER VENTILATION IS REQUIRED TO REDUCE THE RISK OF HAZARDOUS OR EXPLOSIVE GAS BUILDUP DURING INDOOR CHARGING. SEE OWNERS MANUAL.



UNE VENTILATION ADÉQUATE EST NÉCESSAIRE AFIN DE RÉDUIRE LES RISQUES D'ACCUMULATION DE GAZ DANGEREUX OU EXPLOSIFS DURANT LA RECHARGE À L'INTÉRIEUR. VOIR LE MANUEL D'ENTRETIEN.

10. PLEASE BE SURE TO USE CERTIFIED POWER SUPPLY WITH SELV OUTPUT OR CERTIFIED POWER SUPPLY PROVIDING DOUBLE INSULATION EVALUATED BY UL60950-1, UL 62368-1, OR UL61010-1 AND UL61010-2-201 STANDARDS.

VEUILLEZ VOUS ASSURER D'UTILISER UNE ALIMENTATION CERTIFIÉE AVEC SORTIE SELV OU UNE ALIMENTATION CERTIFIÉE OFFRANT UNE DOUBLE ISOLATION ÉVALUÉE PAR LES NORMES UL60950-1 OU UL 62368-1 OU UL61010-1 ET UL61010-2-201.

2. Module Specifications



2.1 Electrical Specifications

Electrical Specifications		
Temperature Control Module	Working Voltage	24 VDC (-15%~+20%)
	Working Current	Max. 80mA@5VDC

2.2 General Specifications

General Specifications		
Size (W x D x H)	Coupler	25 x 105 x 69mm
	I/O Module	12 x 105 x 69mm
Weight	Coupler	80g
	I/O Module	70g
Operating Temperature	0 ... +60°C	
Storage Temperature	-25°C...+85°C	
Relative Humidity	RH 95%, non-condensing	
Altitude Limit	< 2000m	
IP Protection Level	IP 20	
Pollution Degree	II	
Safety Certifications	CE	
Wire Gauge Range (IEC / UL)	0.2mm ² ~ 1.5mm ² / AWG 24~16	
Recommended Terminals	DN00510D DN00710D	

2.3 Temperature Module Specifications

Temperature Input Specifications	
Number of Channels	4
Resolution	16 bit
Sensor Type	RTD (Resistance Temperature Detector)
Wiring Options	2-wire, 3-wire, 4-wire
Sensor Types and Supported Temperature Range	PT50(385.392): -200~850°C PT100(385.392): -200~850°C PT200(385.392): -200~850°C PT500(385.392): -200~850°C PT1000(385.392): -200~300°C NI100(618): -60~180°C NI120(672): -80~260°C
Accuracy	± 1°C
Sensitivity	0.1°C
Temperature Unit	°C, °F
System Indicators	2 green lights (SP, FP), 1 red light (AL)
Channel Indicators	4 Green LEDs, Input Channel Status

3. Temperature Module Panel Overview

GX-RT200

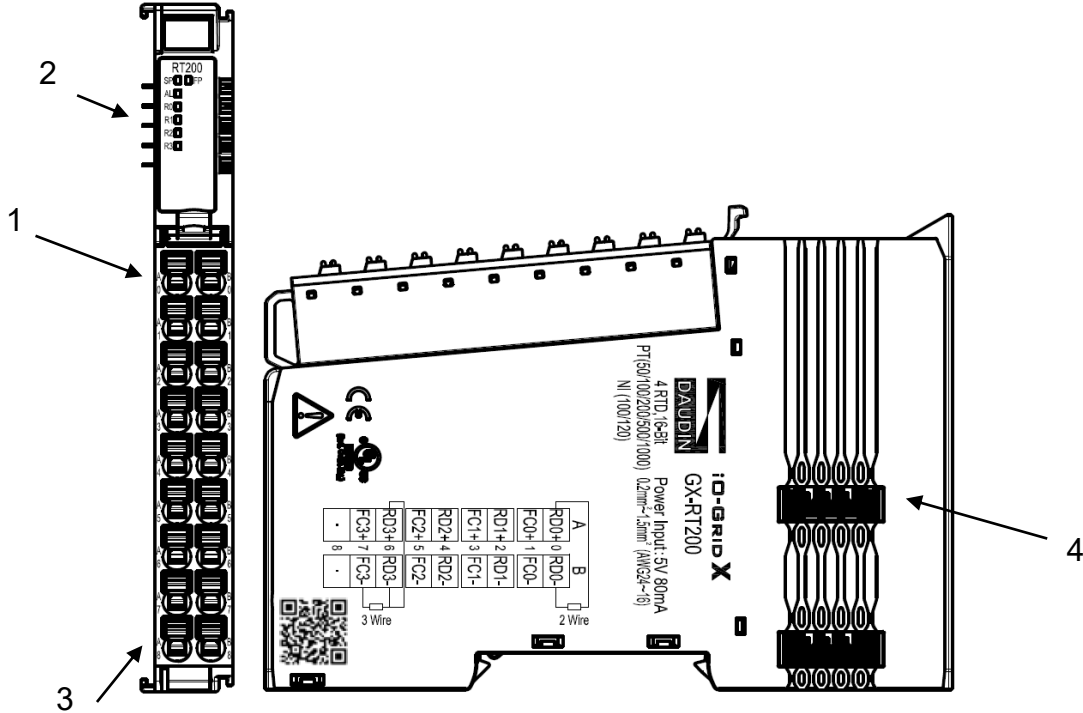

Figure 3.1 GX-RT200

NO.	Name	Description		
1	Signal Terminal	Input signal interface with plug-in terminals		
2	Channel Status Indicator	4 x green LEDs		
3	Terminal	Non-functional plug-in terminal		
4	System Bus	Interface for communication and power supply		
Status Indicators				
Name	Location	Color	Status	Description
Channel Indicators	11.21.31.41	Green	On	Normal
			Flashing	Warning (out of measurement range) or open circuit detection
			Off	Error (module not calibrated)

4. Module Installation and Removal Instructions

4.1 Installation

Align each module unit's side with the direction indicated by the arrow, and snap it onto the upper side of the DIN rail.

Once each unit is positioned, the clip automatically locks onto the rail.

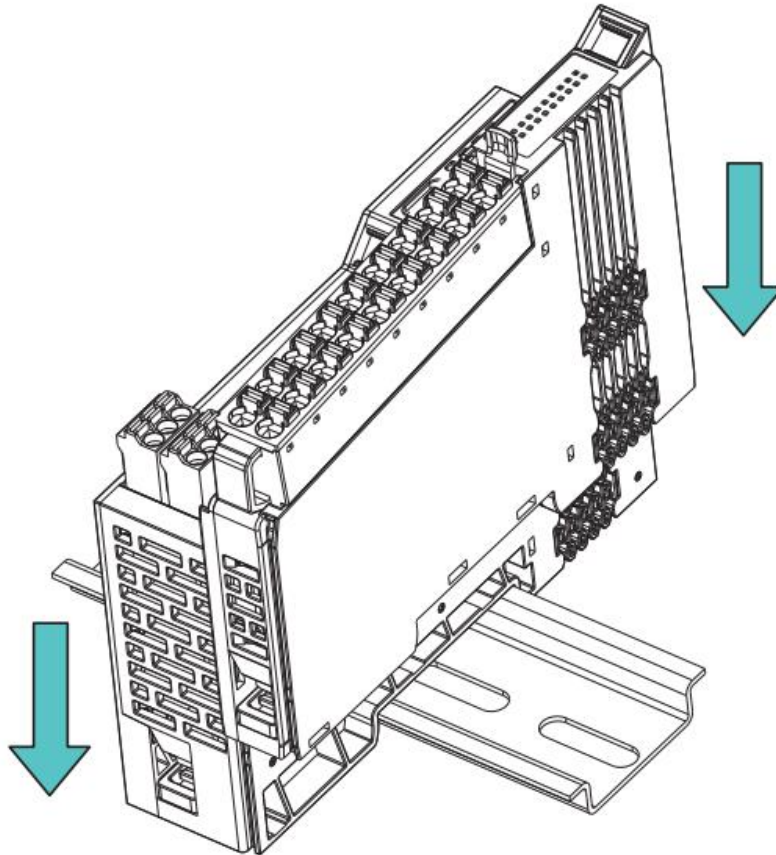

Figure 4.1 Module Installation Diagram

※Note: If the clip fails to engage, press the top of the clip to reset and secure it to the rail.

4.2 Removal

Use a screwdriver to pull down the plastic clip at the bottom of each module.
Following the reverse order of installation, remove each module unit from the DIN rail.

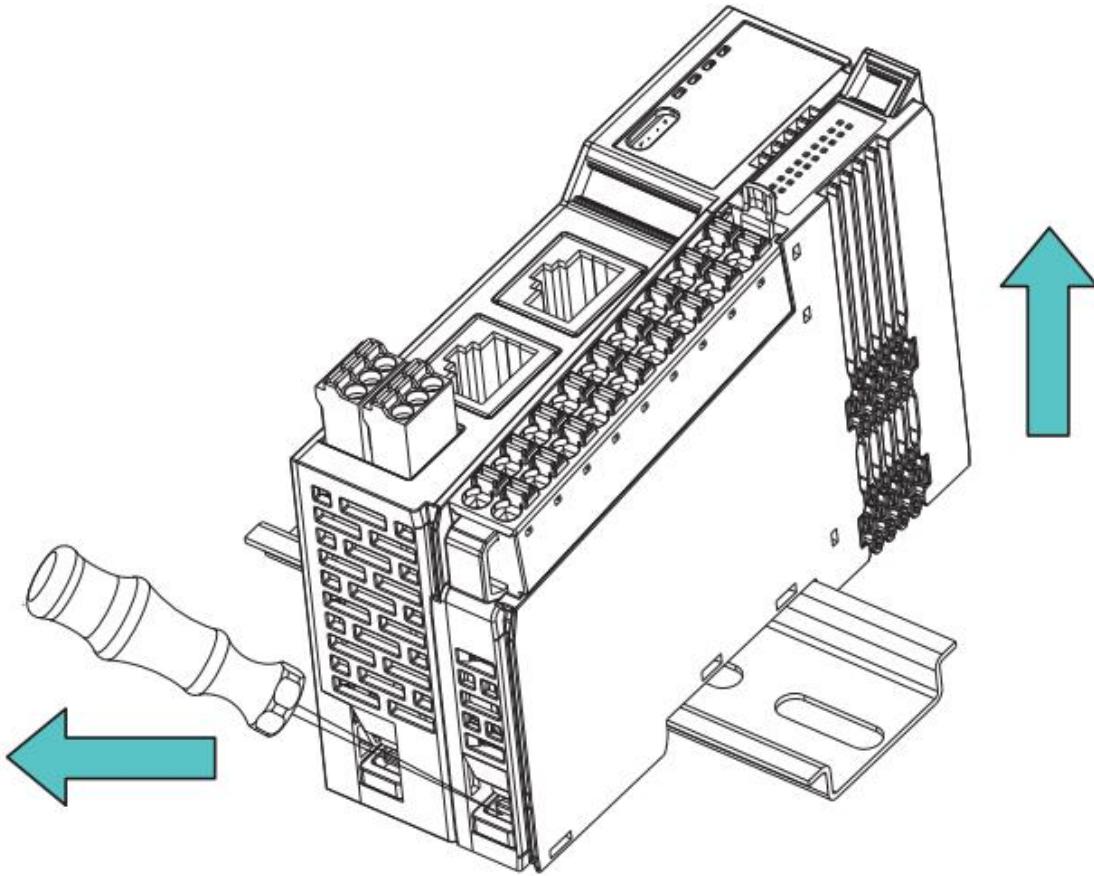

Figure 4.2 Module Removal Diagram

4.3 Module Dimensions

4.3.1. I/O and Functional Module Dimensions

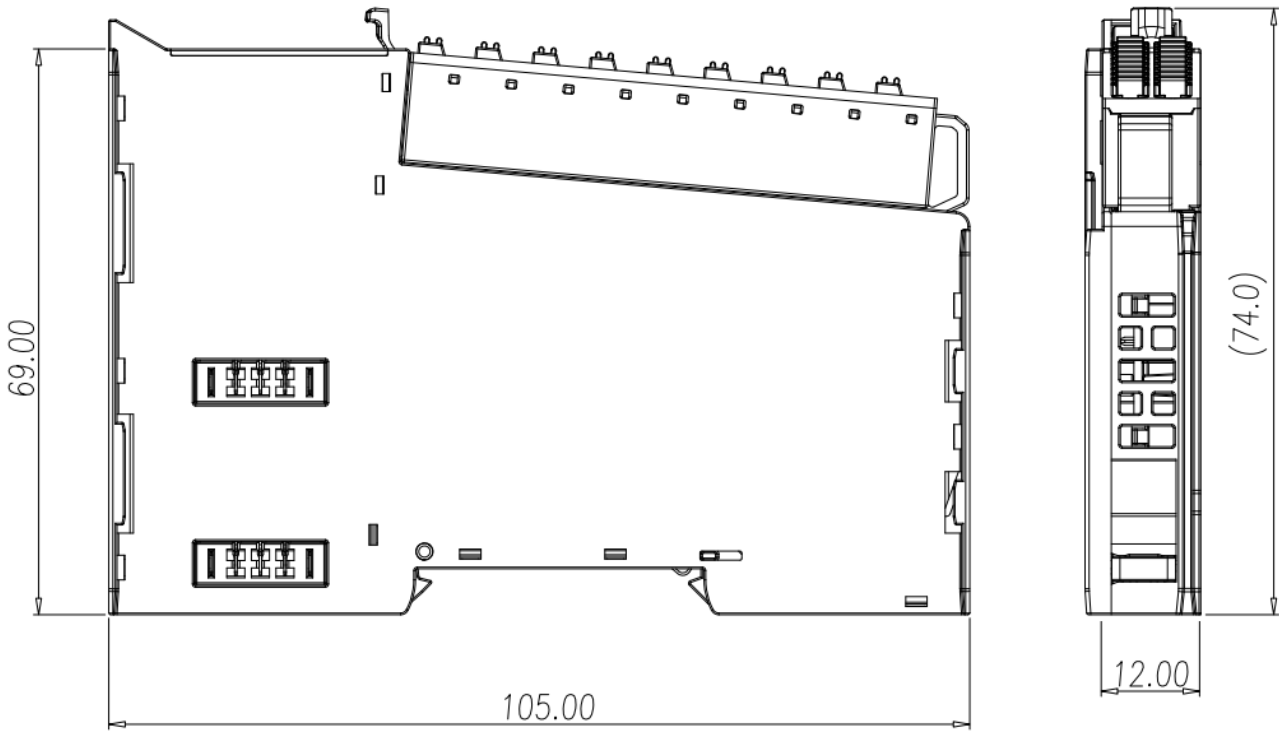
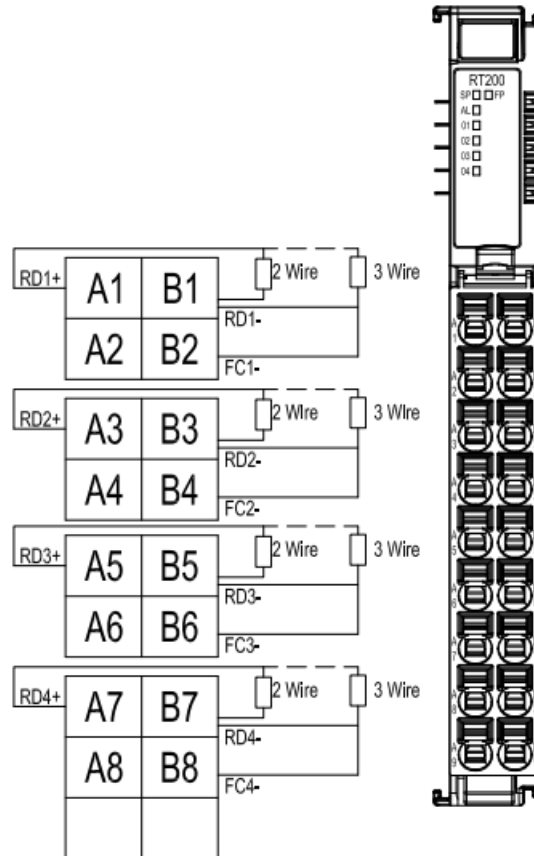

Figure 4.4 I/O Module Dimension Diagram

5. Module Wiring Instructions

5.1 GX-RT200



24V內部導通;0V內部導通

4線式傳感器需改成2線或3線式接入

Figure 5.1 GX-RT200 Wiring Diagram

6. Parameter Setting and Configuration Instructions

6.1 Product Assembly Configuration

As shown in the image below, product configuration primarily involves couplers and I/O modules.

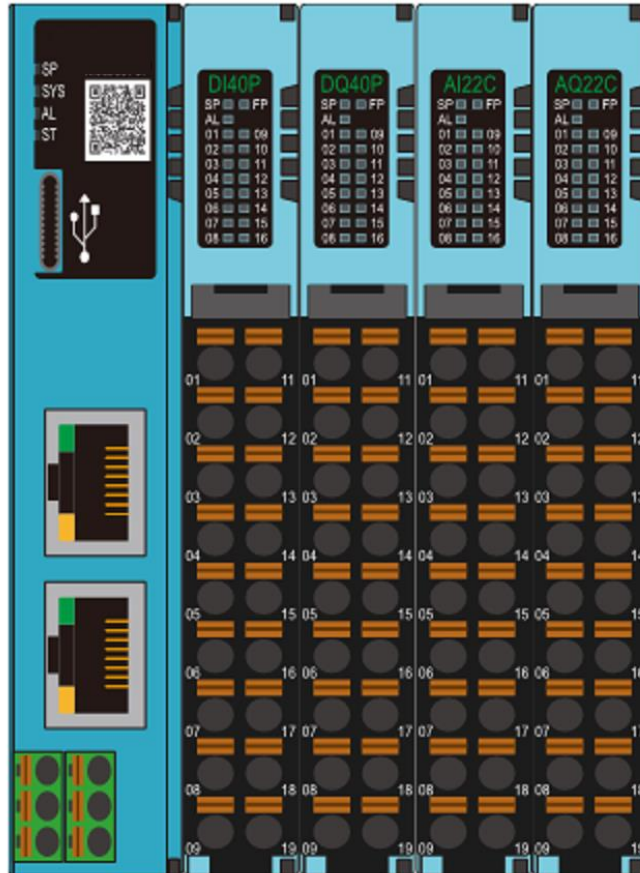

Figure 6.1

Quantity Limit for Configuration

1. A maximum of 64 physical I/O modules can be configured on the coupler.
2. The coupler supports up to 64 modules in total, including both expanded virtual and physical modules.

Virtual Module Limitations

Currently, only GX-CM111 applications are supported. For expanded commands, the virtual module configuration limit is set to 32.

6.2 Coupler Parameter Description

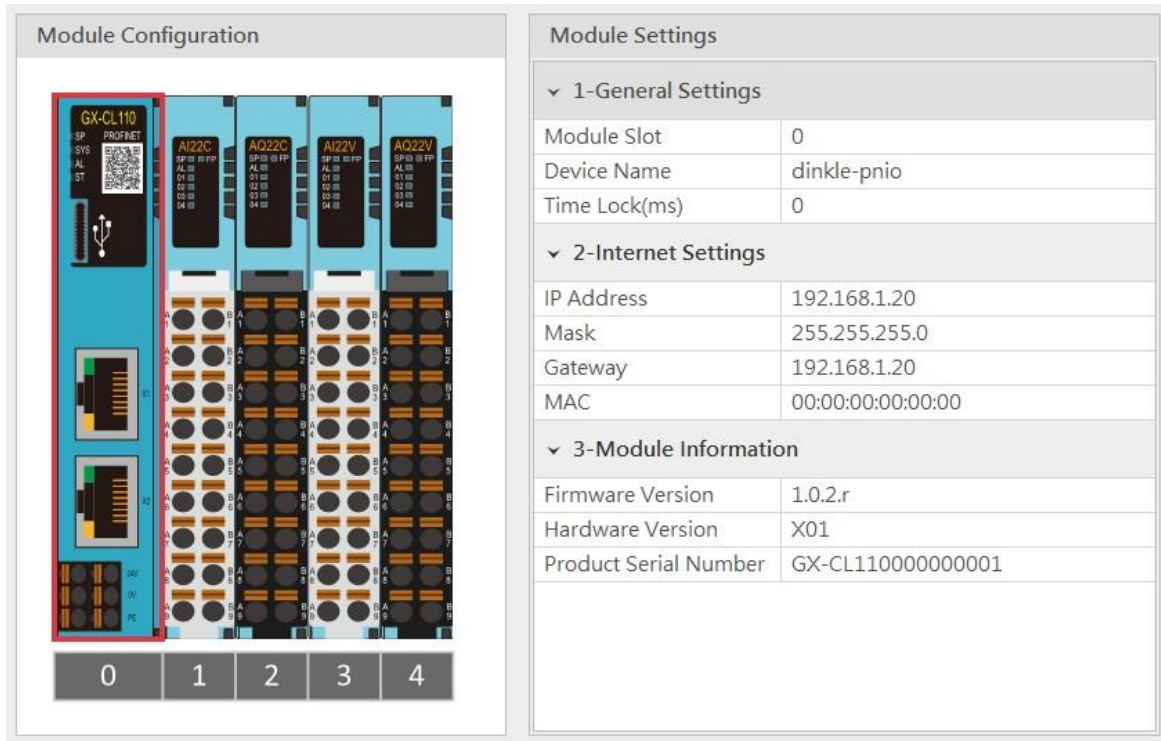

Figure 6.2 Coupler Parameters

6.2.1. General Settings

- **Module Slot:** Slot number (position); fixed at 0 for the coupler.
- **Device Name:** Used for name recognition in Profinet network communication. Follow standard naming conventions for the settings.
- **Reset Time:** Defaults to 0 if not set, meaning the reset function is disabled. If the timeout parameter is set to 1000, it means that within 1 second, the module must exchange IO data with the host computer. If no data exchange occurs within this set time, the module will set the output channels to 0.
- **Hot Swap:** Allows replacement of the same model module without powering down.

6.2.2. Network Settings

- **IP Address:** Can be configured in IPv4 network address format, with a default factory setting of 192.168.1.20.
- **Subnet Mask:** Configurable; default setting is 255.255.255.0.
- **Default Gateway:** Configurable; default setting is 19.168.1.1.20.
- **Physical Address:** Not configurable; MAC address is factory-set for network identification of different device modules.

6.2.3. Module Information

- **Firmware Version:** Current module firmware version
- **Hardware Version:** Module hardware design version
- **Product Serial Number:** Unique identifier for Daudin products

As shown in Figure 6.2, all parameters (except MAC) can be configured as needed. After completing the settings, proceed to upload the parameters as shown in Figure 6.3.

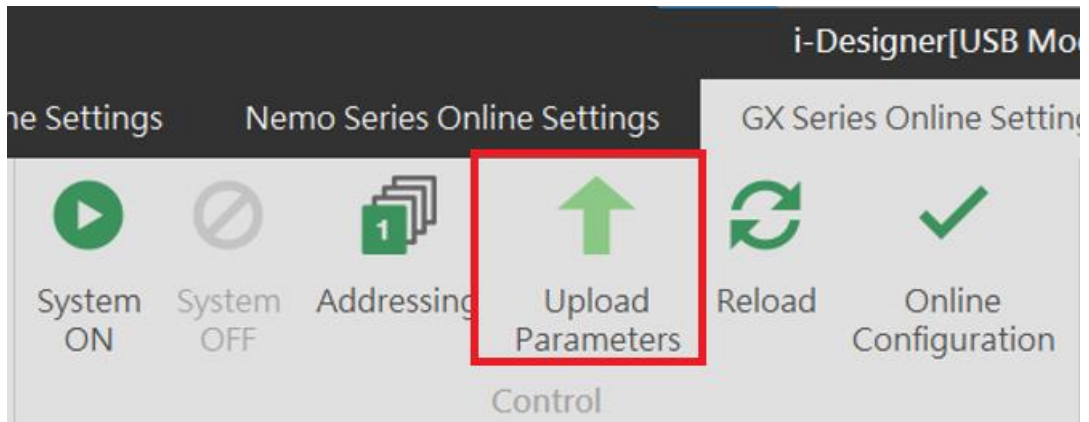

Figure 6.3 Upload Parameters



Before proceeding with relevant settings, the system operation must be paused.

6.3 Factory Defaults

Apart from setting parameters through i-Designer, users can also reset system parameters using the reset button located inside the side casing.

Press Time/Mode	Application Mode
Light Press (<6 seconds)	Module restart (RESET)
Long Press (>6 seconds)	Restore default parameters (Application Mode) ^{Note}

Note: When the user presses the reset button for more than six seconds, the SYS light will illuminate red. After releasing the button, the red light will flash, indicating that the default parameters have been restored.

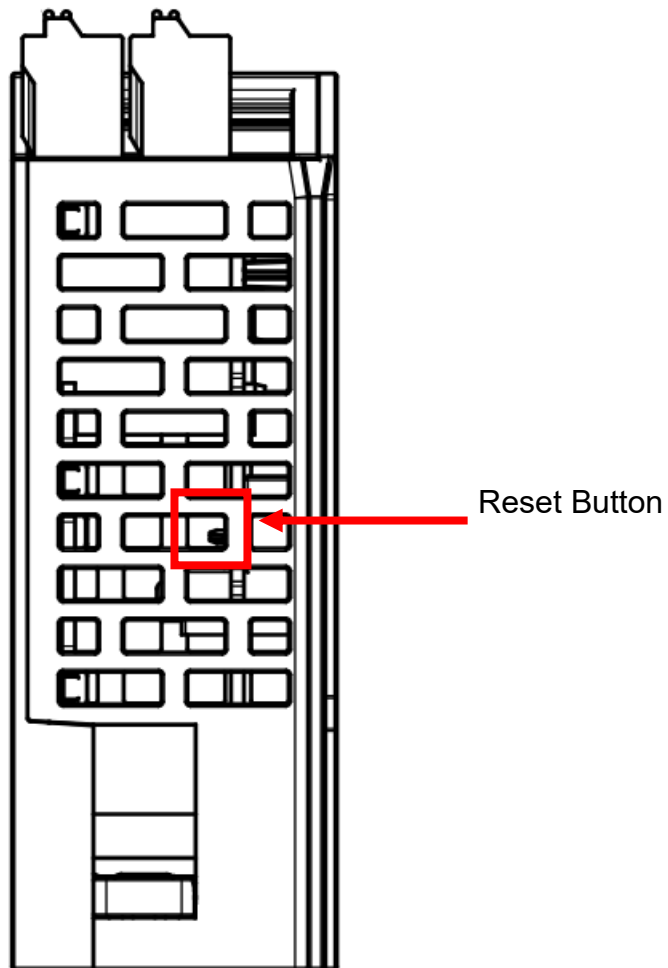

Figure 6.5 System Reset Button

6.4 Error Code Lookup

Users can query system error information and identify timed-out physical modules via the error code module (virtual module). Upon completion of system boot and station setup, the system will automatically place the Error Code Module in the last three available slots, one after another. If no empty slots are available, the system will automatically ignore this placement.

Error Code	Purpose	Length (Word)
System Error	System error information	2
Error Module (01-32)	Physical modules 1-32 triggering timeout	2
Error Module (33-64)	Physical modules 33-64 triggering timeout	2

System Error: System error log, 32-bit data ordered from HSB to LSB

Description	System Error [4 Byte]							
	Bit 7	Bit 6	Bit 5	Bit 4	Bit 3	Bit 2	Bit 1	Bit 0
System Error [3]	Reserved							
System Error [2]	Reserved						Err17	Err16
System Error [1]	Err15	Err14	Err13	Err12	Err11	Err10	Err9	Err8
System Error [0]	Err7	Err6	Err5	Err4	Err3	Err2	Err1	Err0

Err0: Reserved

Err1: Bit set to 1 (Coupler/IO module): Indicates the first boot, with no relevant data in memory

Err2: Bit set to 1 (Coupler/IO module): Indicates memory exceeds the planned size

Err3: Bit set to 1 (Coupler/IO module): Indicates a Checksum error

Err4: Bit set to 1 (Coupler/IO module): Indicates boot failure

Err5: Bit set to 1 (IO module): Indicates that the power is not supplied to the load side of the IO module

Err6: Bit set to 1 (IO module): Indicates IO module over-voltage/over-current

Err7: Bit set to 1 (IO module): Indicates ADC read error in the analog module

Err8: Bit set to 1 (Coupler/IO module): Indicates memory write/erase operation failed

Err9: Bit set to 1 (Coupler): Indicates no saved station record in memory

Err10: Bit set to 1 (Coupler): Indicates the memory station record differs from the boot scan

Err11: Bit set to 1 (Coupler): Indicates no module station number was detected in the boot scan

Err12: Bit set to 1 (Coupler): Indicates communication timeout in Polling Mode for IO modules

Err13: Bit set to 1 (Coupler): Indicates station failure

Err14: Bit set to 1 (Coupler/IO module): Indicates data length in operating mode exceeds the set value

Err15: Bit set to 1 (Coupler): Indicates hot-swap function recovery failure

Err16: Bit set to 1 (Coupler): Indicates network initialization failure

Err17: Bit set to 1 (Coupler): Indicates register address exceeds the control range

Error Module (01-32) : Records IO module timeout information, 32-bit data ordered from HSB to LSB

Description	Error Module (01-32) [4 Byte]							
	Bit 7	Bit 6	Bit 5	Bit 4	Bit 3	Bit 2	Bit 1	Bit 0
Module Error [3]	Slot32	Slot31	Slot30	Slot29	Slot28	Slot27	Slot26	Slot25
Module Error [2]	Slot24	Slot23	Slot22	Slot21	Slot20	Slot19	Slot18	Slot17
Module Error [1]	Slot16	Slot15	Slot14	Slot13	Slot12	Slot11	Slot10	Slot9
Module Error [0]	Slot8	Slot7	Slot6	Slot5	Slot4	Slot3	Slot2	Slot1

Slot1: IO module ID 1; Bit set to 1 indicates polling timeout for this module

Slot2: IO module ID 2; Bit set to 1 indicates polling timeout for this module

Slot3: IO module ID 3; Bit set to 1 indicates polling timeout for this module

:

(and so on)

:

Slot32: IO module ID 32; Bit set to 1 indicates polling timeout for this module

Error Module (33-64) : Records IO module timeout information, 32-bit data ordered from HSB to LSB

Description	Error Module (33-64) [4 Byte]							
	Bit 7	Bit 6	Bit 5	Bit 4	Bit 3	Bit 2	Bit 1	Bit 0
Module Error [3]	Slot64	Slot63	Slot62	Slot61	Slot60	Slot59	Slot58	Slot57
Module Error [2]	Slot56	Slot55	Slot54	Slot53	Slot52	Slot51	Slot50	Slot49
Module Error [1]	Slot48	Slot47	Slot46	Slot45	Slot44	Slot43	Slot42	Slot41
Module Error [0]	Slot40	Slot39	Slot38	Slot37	Slot36	Slot35	Slot34	Slot33

Slot33: IO module ID 33; Bit set to 1 indicates polling timeout for this module

Slot34: IO module ID 34; Bit set to 1 indicates polling timeout for this module

Slot35: IO module ID 35; Bit set to 1 indicates polling timeout for this module

:

(and so on)

:

Slot64: IO module ID 64; Bit set to 1 indicates polling timeout for this module

6.5 Temperature Module Parameters

RTD Analog Input Module

Input Data Description

Input Data								
Bit No	Bit7	Bit6	Bit5	Bit4	Bit3	Bit2	Bit1	Bit0
Byte 0	Analog Input Data(CH1)							
Byte 1								
Byte 2	Analog Input Data(CH2)							
Byte 3								
Byte 4	Analog Input Data(CH3)							
Byte 5								
Byte 6	Analog Input Data(CH4)							
Byte 7								

Value Definition

Analog Input Data CH#	<p>The measured temperature for each channel, shown with 0.1-degree accuracy in either °C or °F.</p> <p>If set to °C and the reading is 123, it translates to 12.3°C.</p> <p>A reading of 32767 (0x7FFF) indicates either an open circuit or that the measurement has exceeded the upper limit.</p> <p>A reading of 32768 (0x8000) signals that the measurement is below the lower limit.</p>
-----------------------	---

Supported Range for Each Sensor Type

Sensor Types and Ranges: PT50, PT100, PT200, PT500

Analog Input Data			
Temperature	Decimal	Hex	Location
>860	32767	7FFF	Exceeds the upper limit
850.0	8500	2134	Rated range
:	:	:	
-200.0	-2000	F830	
<-210.0	-32768	8000	Exceeds the lower limit



Sensor Types and Ranges: PT100

Analog Input Data			
Temperature	Decimal	Hex	Location
>310	32767	7FFF	Exceeds the upper limit
300.0	3000	BB8	Rated range
:	:	:	
-200.0	-2000	F830	
<-210.0	-32768	8000	Exceeds the lower limit

Sensor Types and Ranges: NI100

Analog Input Data			
Temperature	Decimal	Hex	Location
>190	32767	7FFF	Exceeds the upper limit
180.0	1800	708	Rated range
:	:	:	
-60.0	-600	FDA8	
<-70.0	-32768	8000	Exceeds the lower limit

Sensor Types and Ranges: NI120

Analog Input Data			
Temperature	Decimal	Hex	Location
>270	32767	7FFF	Exceeds the upper limit
260.0	2600	A28	Rated range
:	:	:	
-80.0	-800	FCE0	
<-90.0	-32768	8000	Exceeds the lower limit

7. Appendix I: i-Designer Instructions

7.1 Installation

Download the i-Designer program from the official website, then click on the program (as shown in the figure) to install it.



Figure 7.1 Program Icon

After reading the user agreement, please check the box and click Start Installation.



Figure 7.2 Click Start Installation

During installation, the progress will be displayed.

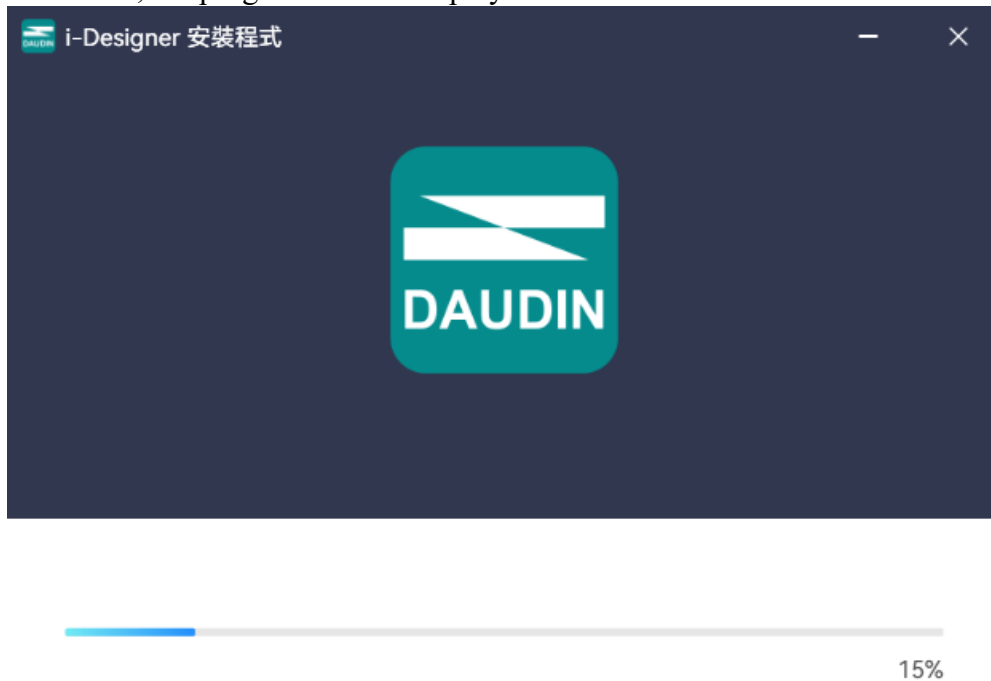

Figure 7.3 Installation Progress

Once the software installation is complete, you can choose to run it immediately by clicking the Finish button.



Figure 7.4 Installation Complete

7.2 UI Screen Description

After installation, locate the program icon on the desktop and click it to open the settings screen (see the figure below).



Figure 7.5 Program Icon

The screen is organized as follows, from top to bottom:

- I. Tab Area: Select different product series or switch languages.
- II. Function Key Area: Displays different function keys based on the selected tab.
- III. Display and Configuration Area: Shows the module status and settings.
- IV. Progress Display Area: Displays the progress of various functions in percentages, helping users understand the current execution status, such as configuration or updates.



Figure 7.6 Default Homepage

Tab Area:

- (1) Homepage Tab: Provides information about i-Designer and options for switching the language.
- (2) Product Settings Tab: Used for setting parameters for various **iO-GRID** product series.

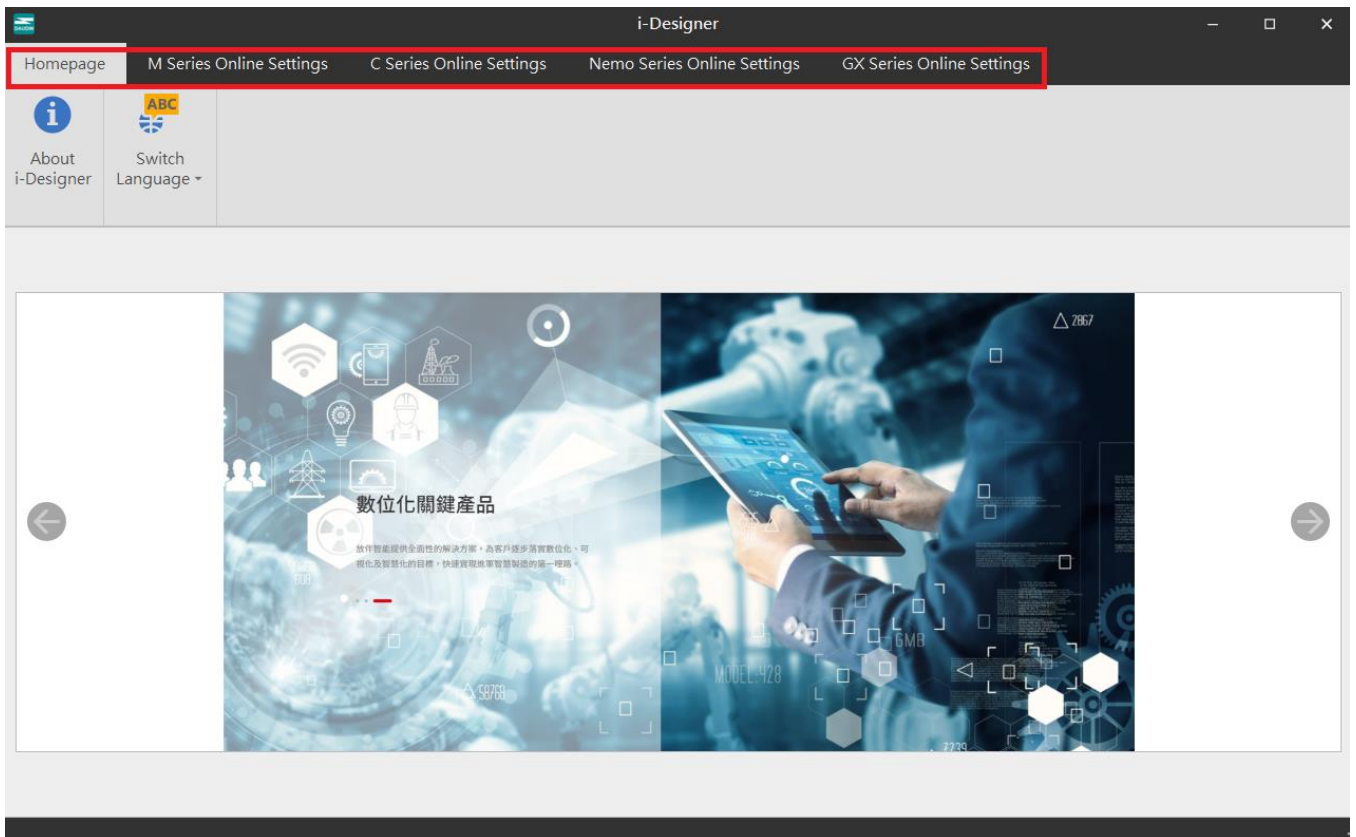















Figure 7.7 Tab

Function Key Area:

The function keys displayed here vary based on the selected tab and product. The relevant descriptions are as follows:

Icon	Name	Description
	About i-Designer	Shows software version information.
	Switch Languages	Switches between Traditional Chinese, Simplified Chinese, and English.
	Connection Mode	Offers automatic or manual module connection modes.
	Connection Info	
	Connect	Connects to the module.
	Disconnect	Disconnects from the module.
	System stop	Temporarily stops the module system.
	System running	Starts the module system.
	Auto Station Assignment	Reconfigures the station numbers of the module system.
	Upload parameters	Updates the module settings.
	Online Adjustment	
	Check for Updates	Searches and compares the current module firmware version to check if it's the latest.
	Firmware update	Manually updates the module firmware.
	Point Information Overview	Displays all operational data of the modules.

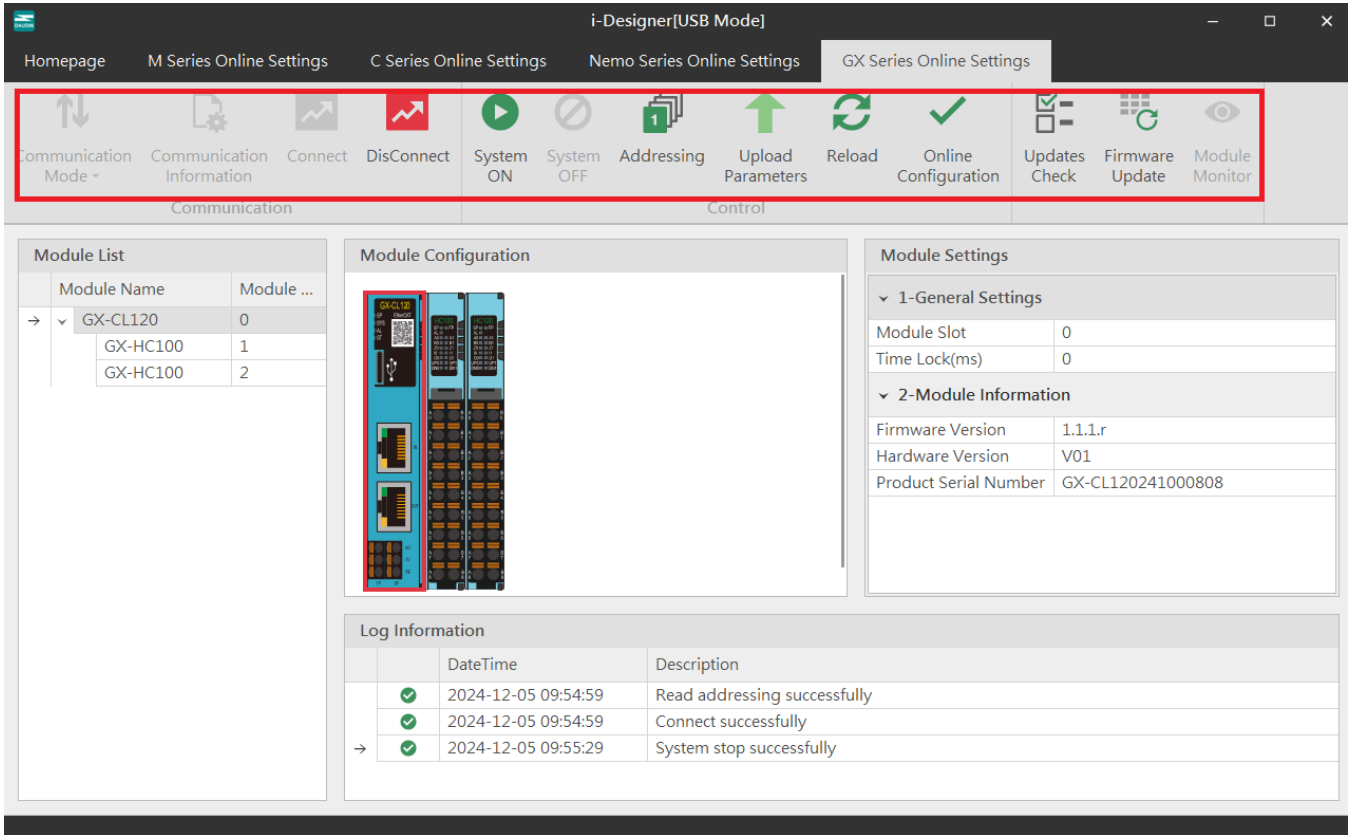

Figure 7.8 Function Key Area

Display and Configuration Area

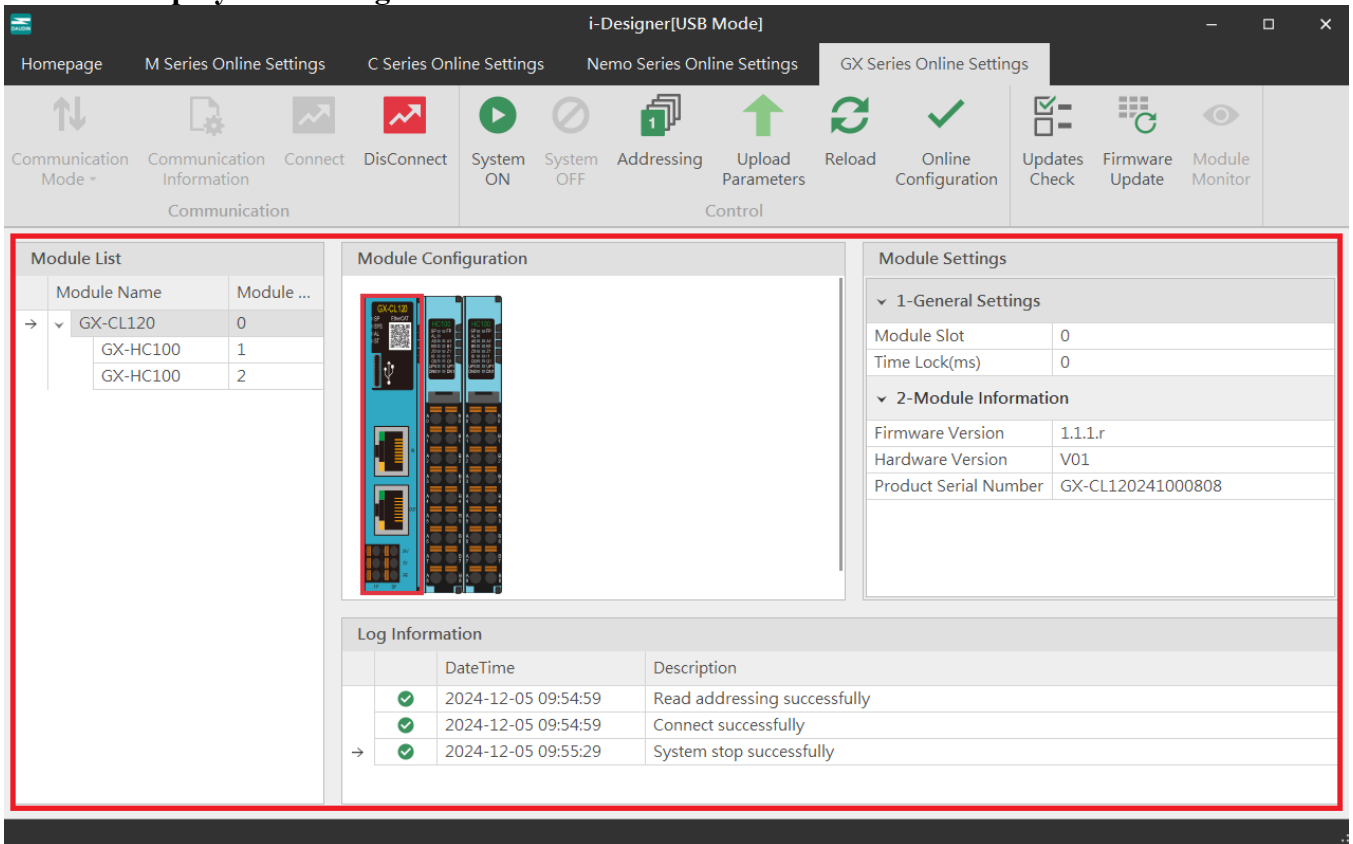

Figure 7.9 Display and Configuration Area

i-Designer[USB Mode]

[Homepage](#)
[M Series Online Settings](#)
[C Series Online Settings](#)
[Nemo Series Online Settings](#)
[GX Series Online Settings](#)

Communication Mode
Communication Information
Connect
DisConnect
System ON
System OFF
Addressing
Upload Parameters
Reload
Online Configuration
Updates Check
Firmware Update
Module Monitor

Module List

Module Name	Module ...
→ GX-CL120	0
GX-HC100	1
GX-HC100	2

Module Configuration **Addressing**

Module Settings

▼ 1-General Settings

Module Slot	0
Time Lock(ms)	0

▼ 2-Module Information

Firmware Version	1.1.1.r
Hardware Version	V01
Product Serial Number	GX-CL120241000808

Log Information

	DateTime	Description
✓	2024-12-05 09:54:59	Read addressing successfully
✓	2024-12-05 09:54:59	Connect successfully
✓	2024-12-05 09:55:29	System stop successfully
→ ✓	2024-12-05 09:59:31	Addressing...

Figure 7.10 Progress Display Area

7.3 i-Designer Information Verification

Click on the homepage -> About i-Designer

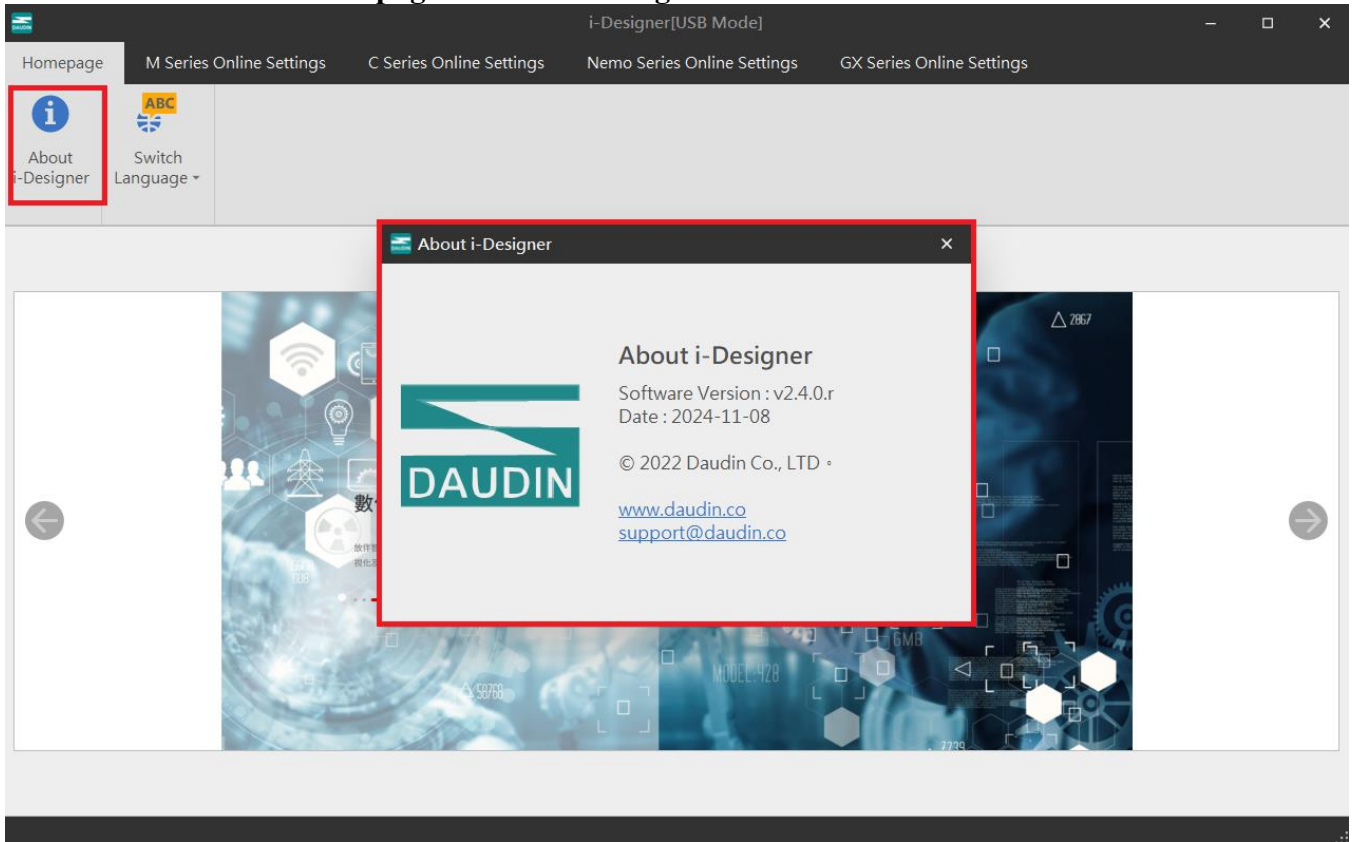

Figure 7.11 Software Information

7.4 Language Settings

i-Designer currently supports three languages: Traditional Chinese, Simplified Chinese, and English. Use this feature to change the language.

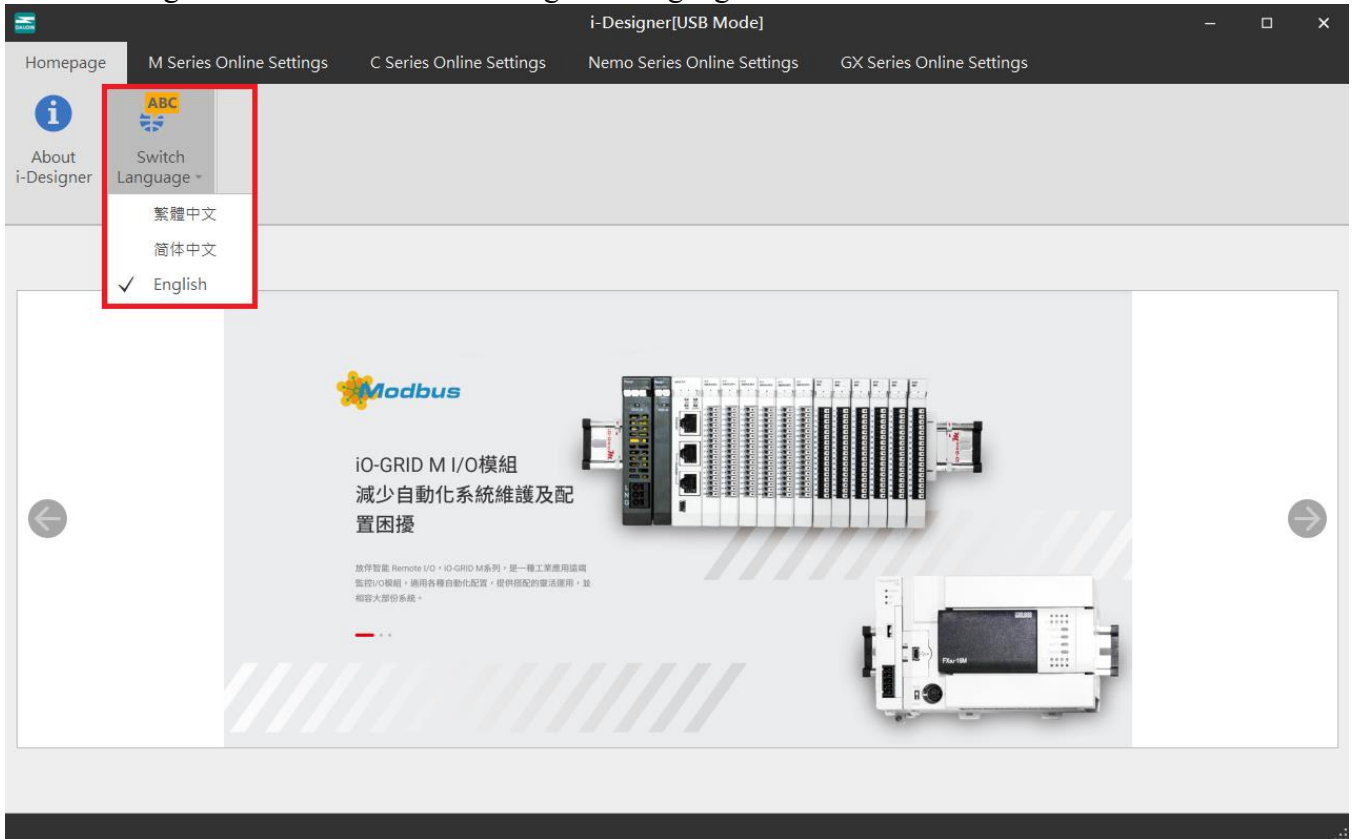

Figure 7.12 Language Selection

7.5 COM Port Connection Settings

Communication between i-Designer and the **iO-GRID** coupler module is primarily handled through the COM Port interface. Connection modes include automatic module search and manual COM Port setup.

Before setting up a custom connection with the **iO-GRID**, please confirm the COM Port number assigned to the coupler module to proceed with configuration.

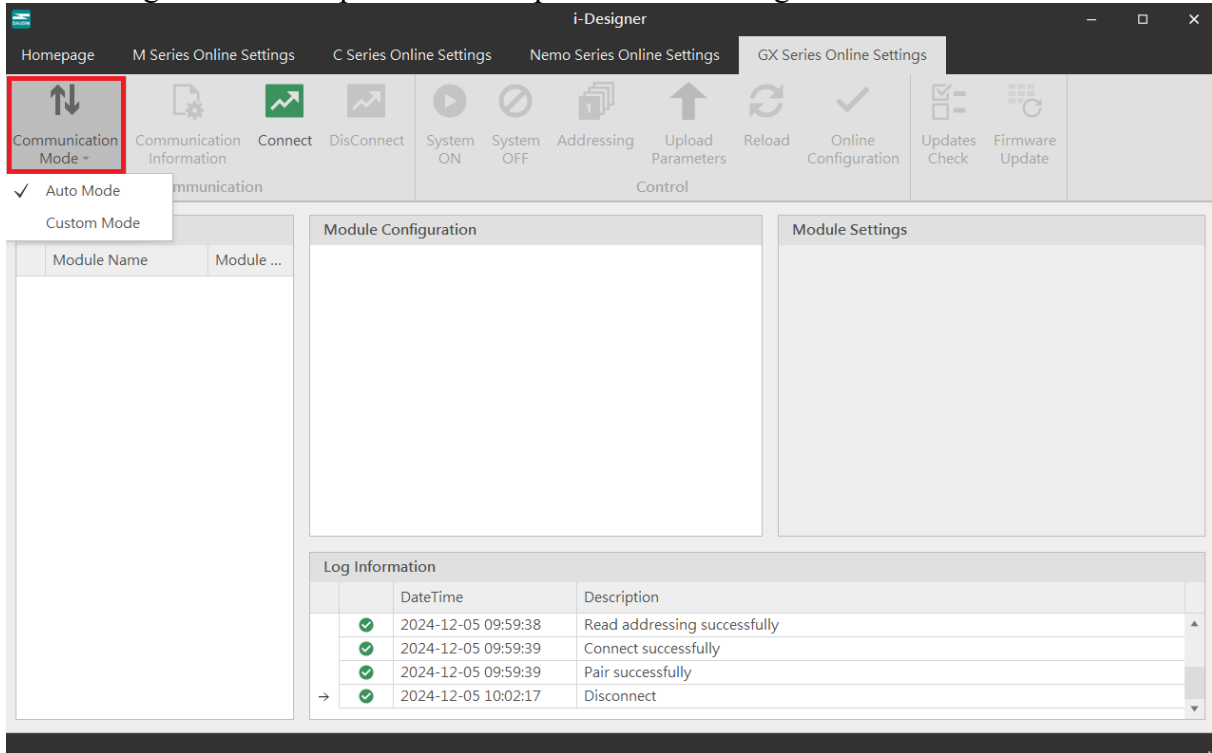

Figure 7.13 Connection Modes

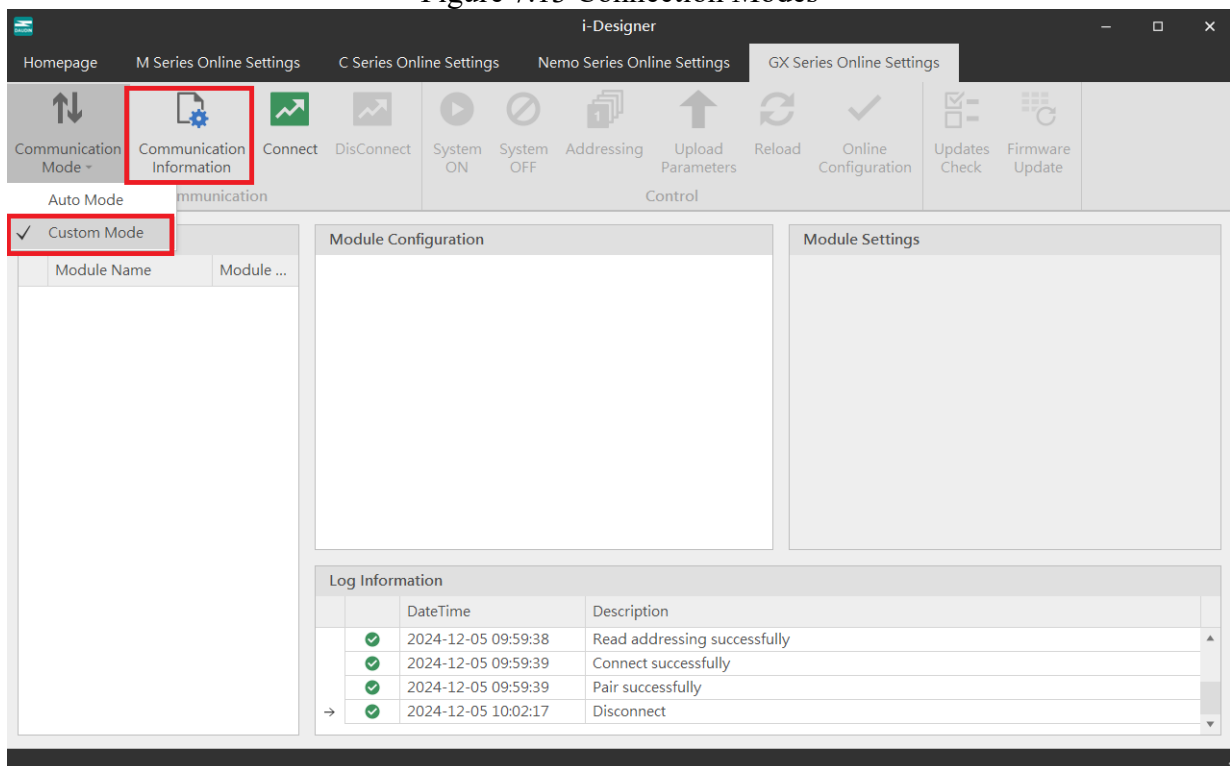

Figure 7.14 Custom Mode Setup

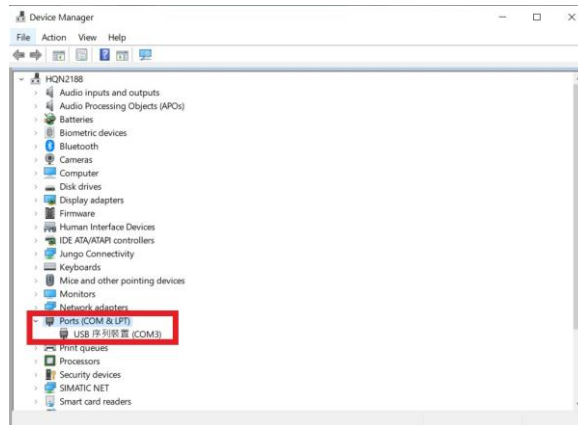

Figure 7.15 Checking the COM Port Number in Device Manager

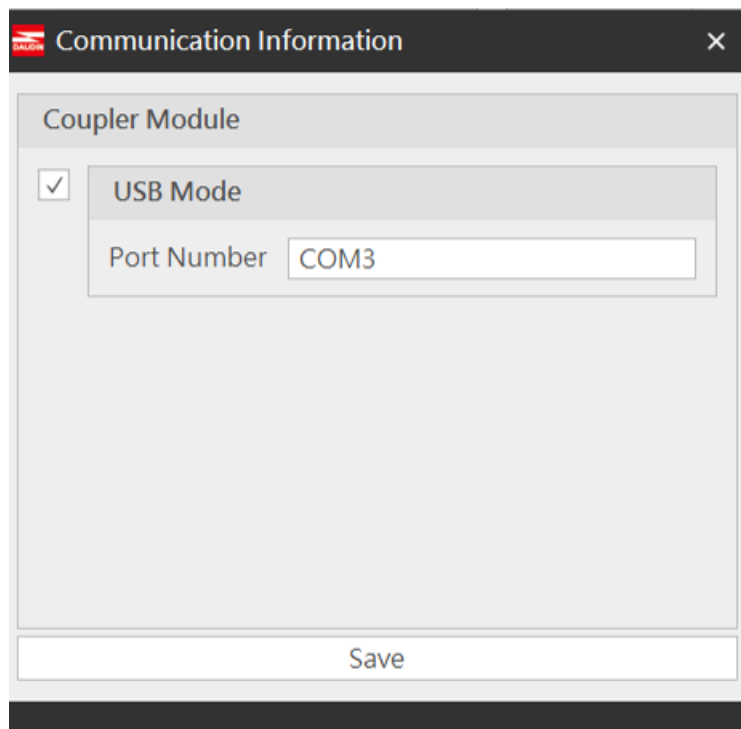

Figure 7.16 Configuring COM Port Settings

7.6 Connection Setting Instructions

Once the connection is successful, the current connection mode will be displayed in the window, and the firmware version of all modules will be detected. If the system is running, a pop-up window will ask whether to stop the system to perform firmware version detection for all modules.

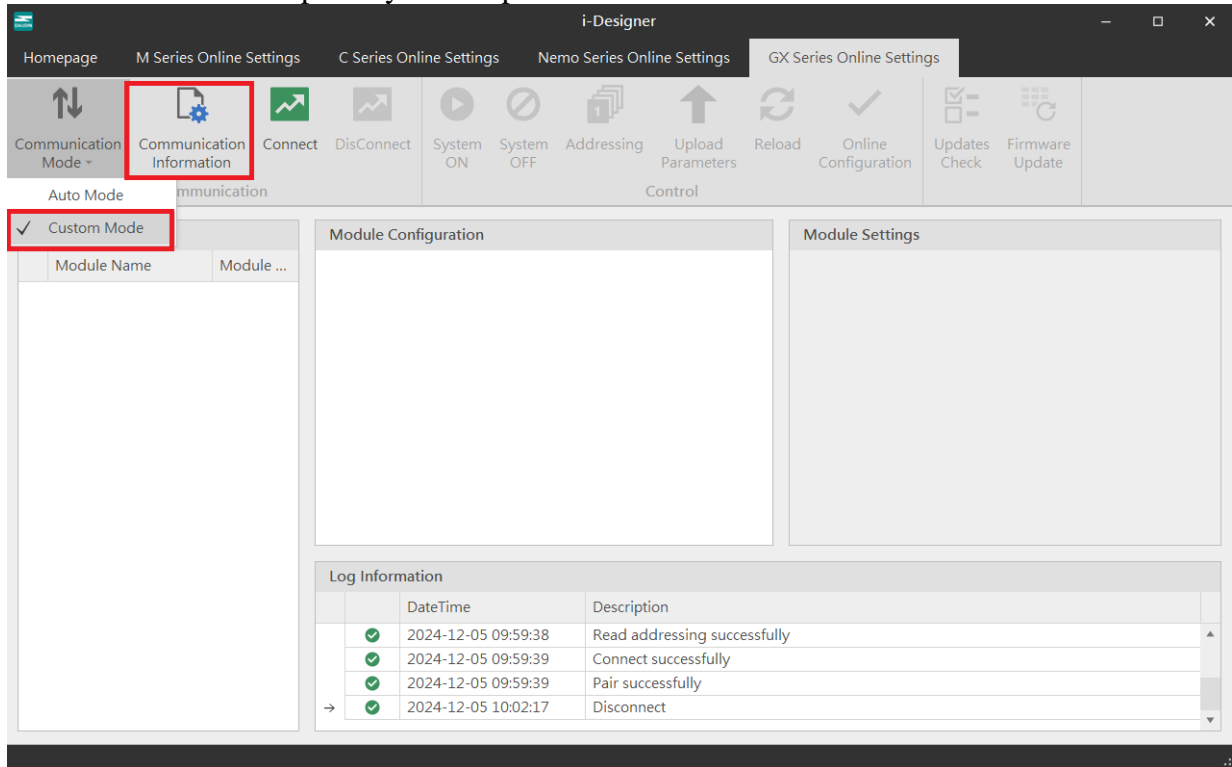

Figure 7.17 Setting Connection

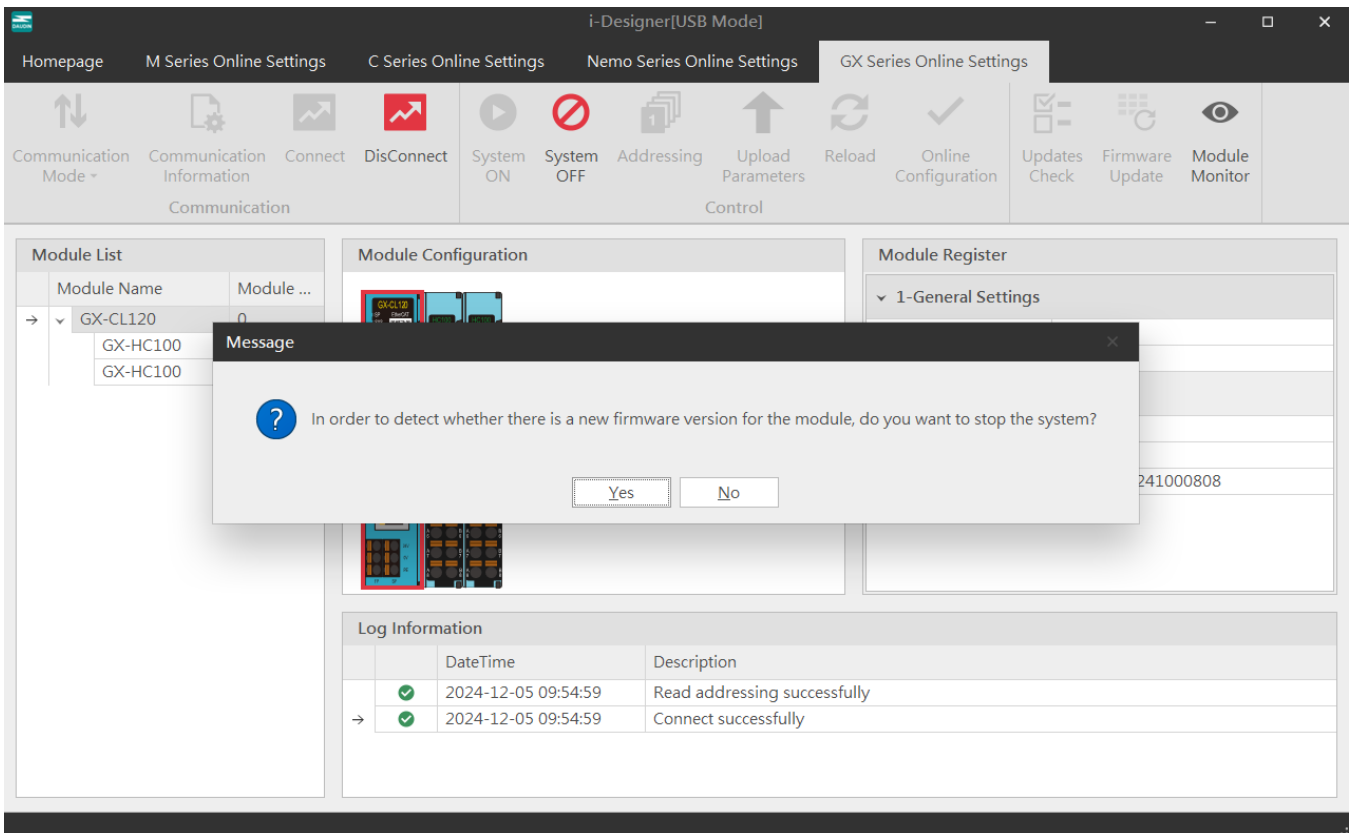

Figure 7.18 After Connection, The Module Automatically Checks For Updates And Notifies You

If the system is stopped, i-Designer will automatically detect the module version.

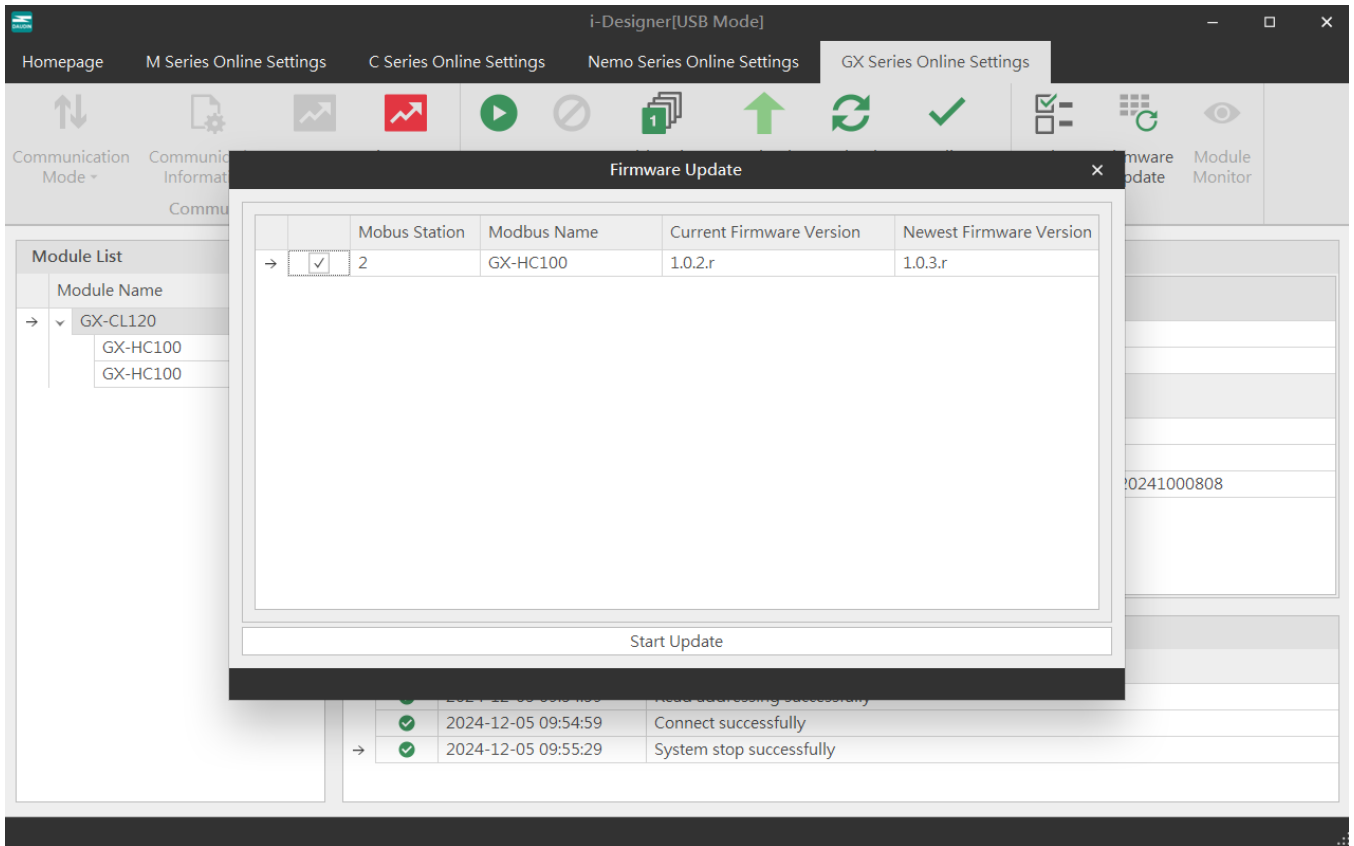

Figure 7.19 Module Version Data

Only after the system is stopped can the module functions be configured.

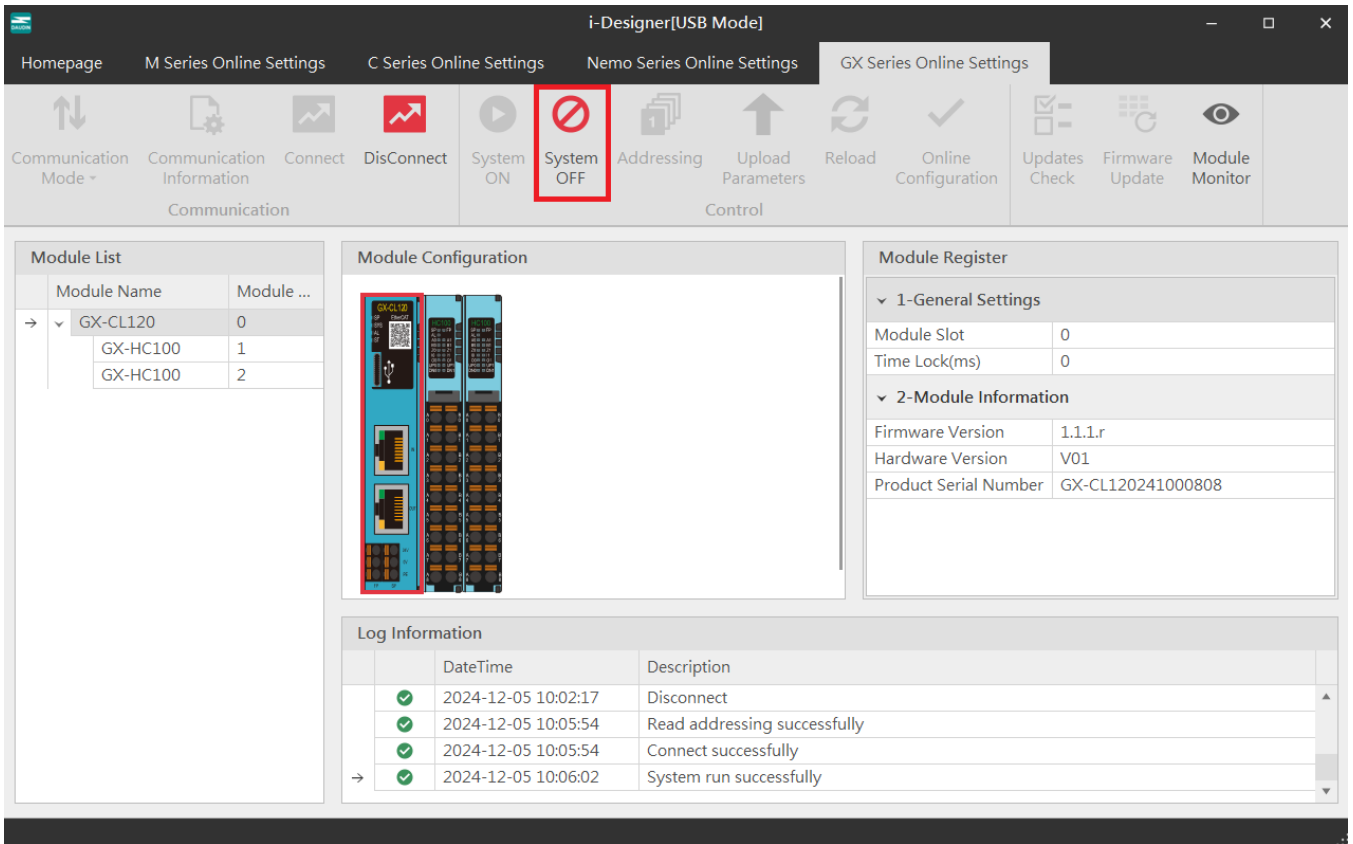

Figure 7.20 System Stop Screen

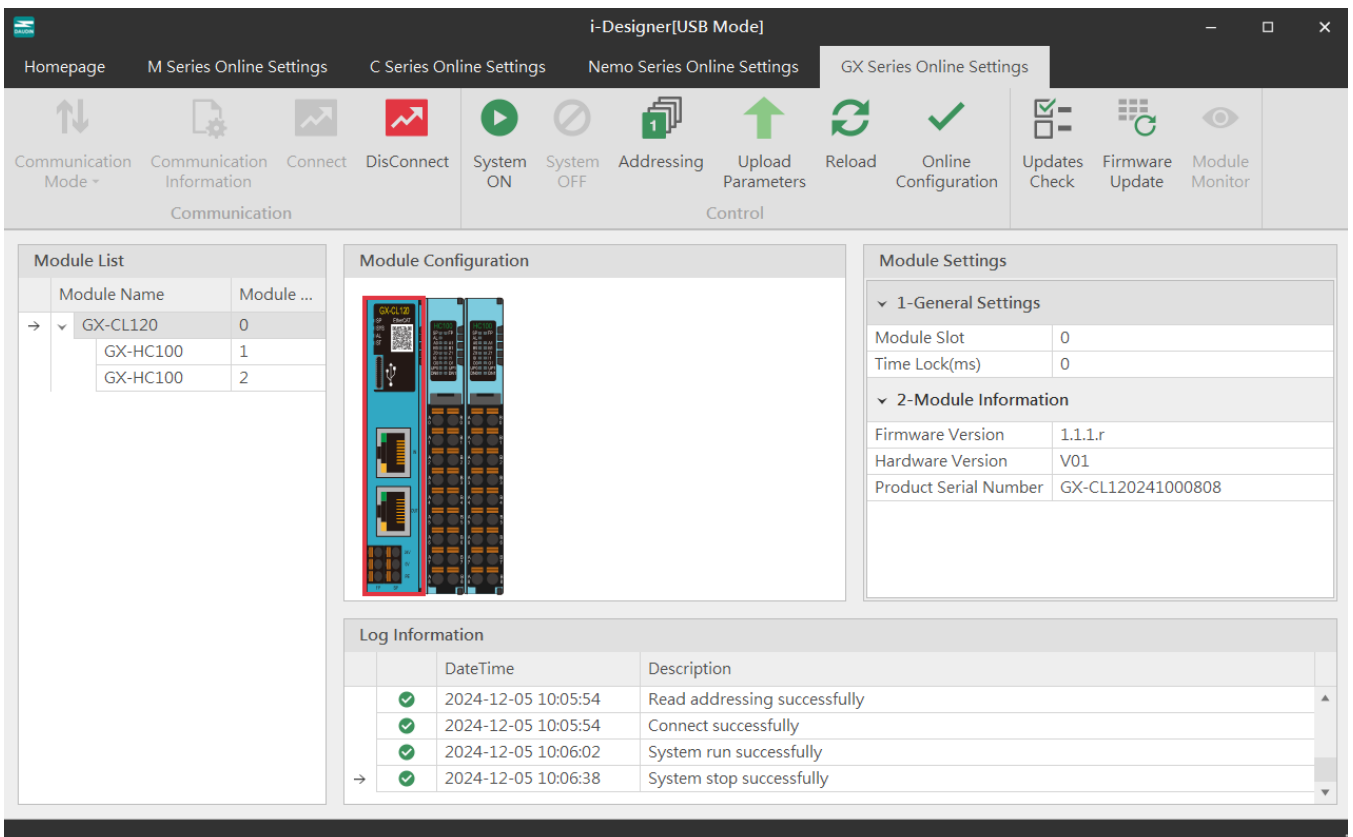
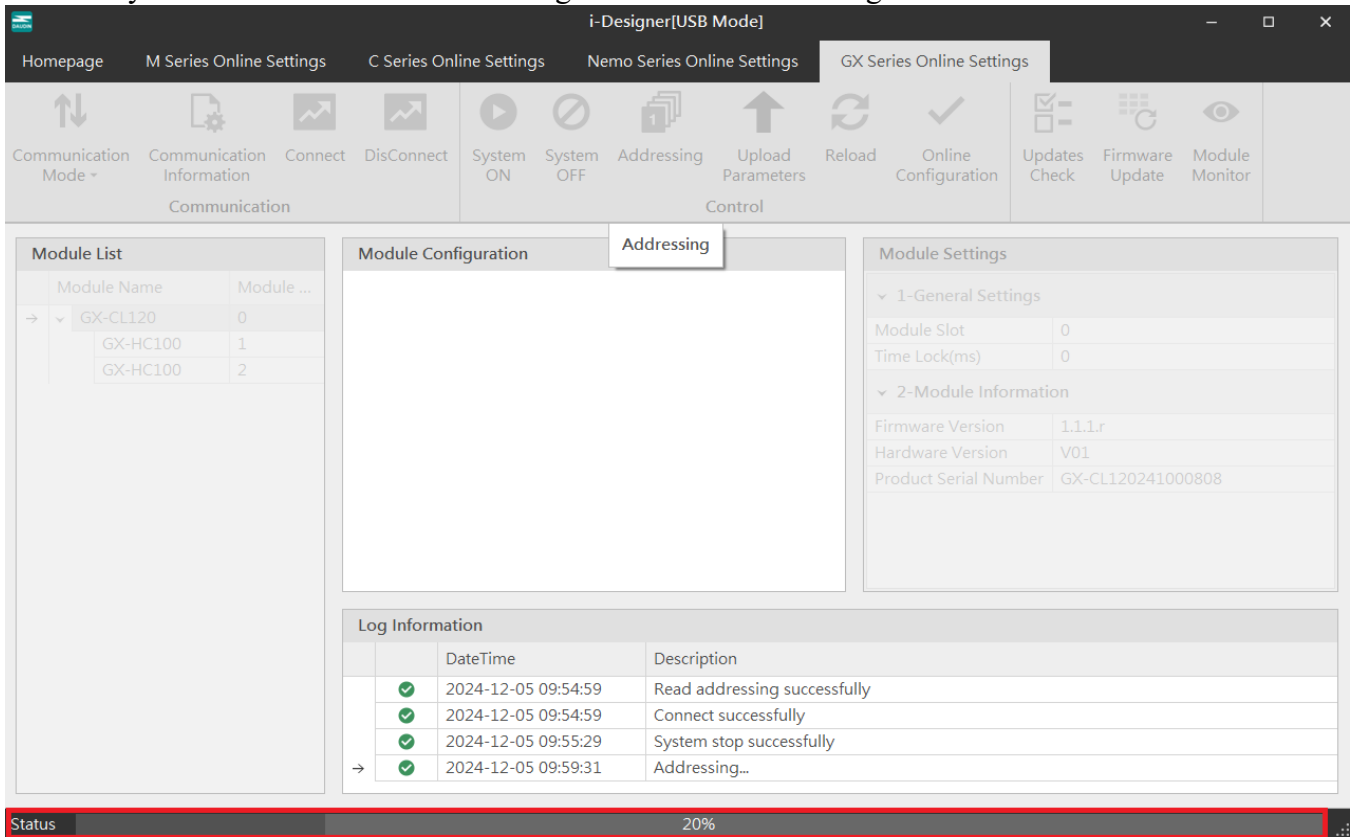

Figure 7.21 System Stop Screen

When connecting to X series modules, if the listed modules do not match the actual modules, you can search for modules through the Auto Station Assignment function.



The screenshot shows the 'i-Designer[USB Mode]' software interface. The 'GX Series Online Settings' window is open, with the 'Addressing' tab selected. The interface includes a top navigation bar with options like 'Homepage', 'M Series Online Settings', 'C Series Online Settings', 'Nemo Series Online Settings', and 'GX Series Online Settings'. Below this is a toolbar with various icons for communication, control, and configuration. The main workspace is divided into several sections:

- Module List:** A table showing the current module configuration.

Module Name	Module ...
GX-CL120	0
GX-HC100	1
GX-HC100	2
- Module Configuration:** A large empty area for configuring the selected module.
- Module Settings:** A panel with expandable sections:
 - 1-General Settings:**

Module Slot	0
Time Lock(ms)	0
 - 2-Module Information:**

Firmware Version	1.1.1.r
Hardware Version	V01
Product Serial Number	GX-CL120241000808
- Log Information:** A table showing the history of operations.

	DateTime	Description
✓	2024-12-05 09:54:59	Read addressing successfully
✓	2024-12-05 09:54:59	Connect successfully
✓	2024-12-05 09:55:29	System stop successfully
→ ✓	2024-12-05 09:59:31	Addressing...

The bottom status bar shows 'Status' and '20%' progress.

Figure 7.22 Station Assignment in Progress

After configuring the module functions, you must click "Upload Parameters" to save the settings correctly.

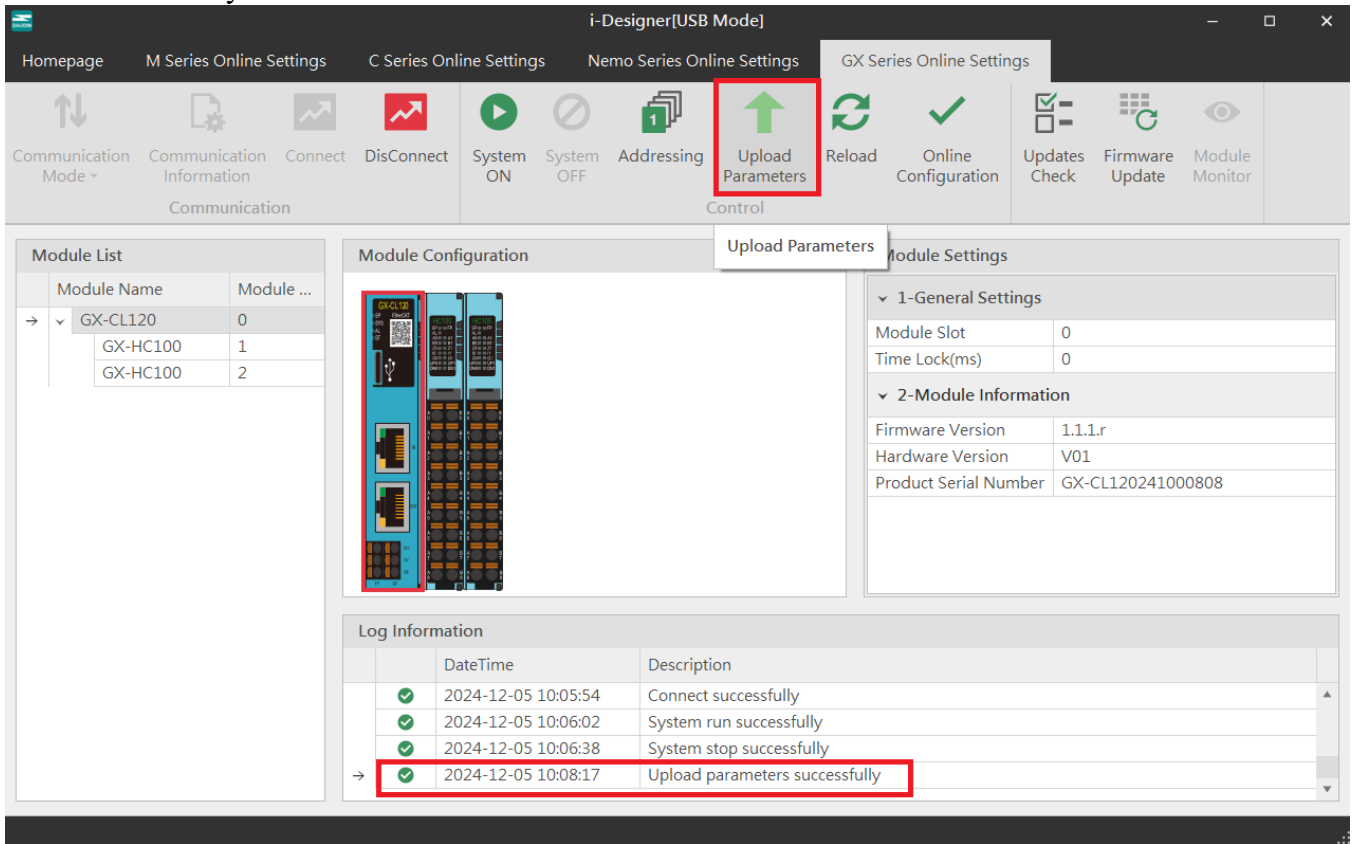

Figure 7.23 Screen After Uploading Parameters

You can view the IO point status through the online debugging feature.

Note: You must disconnect from the external master station before proceeding.

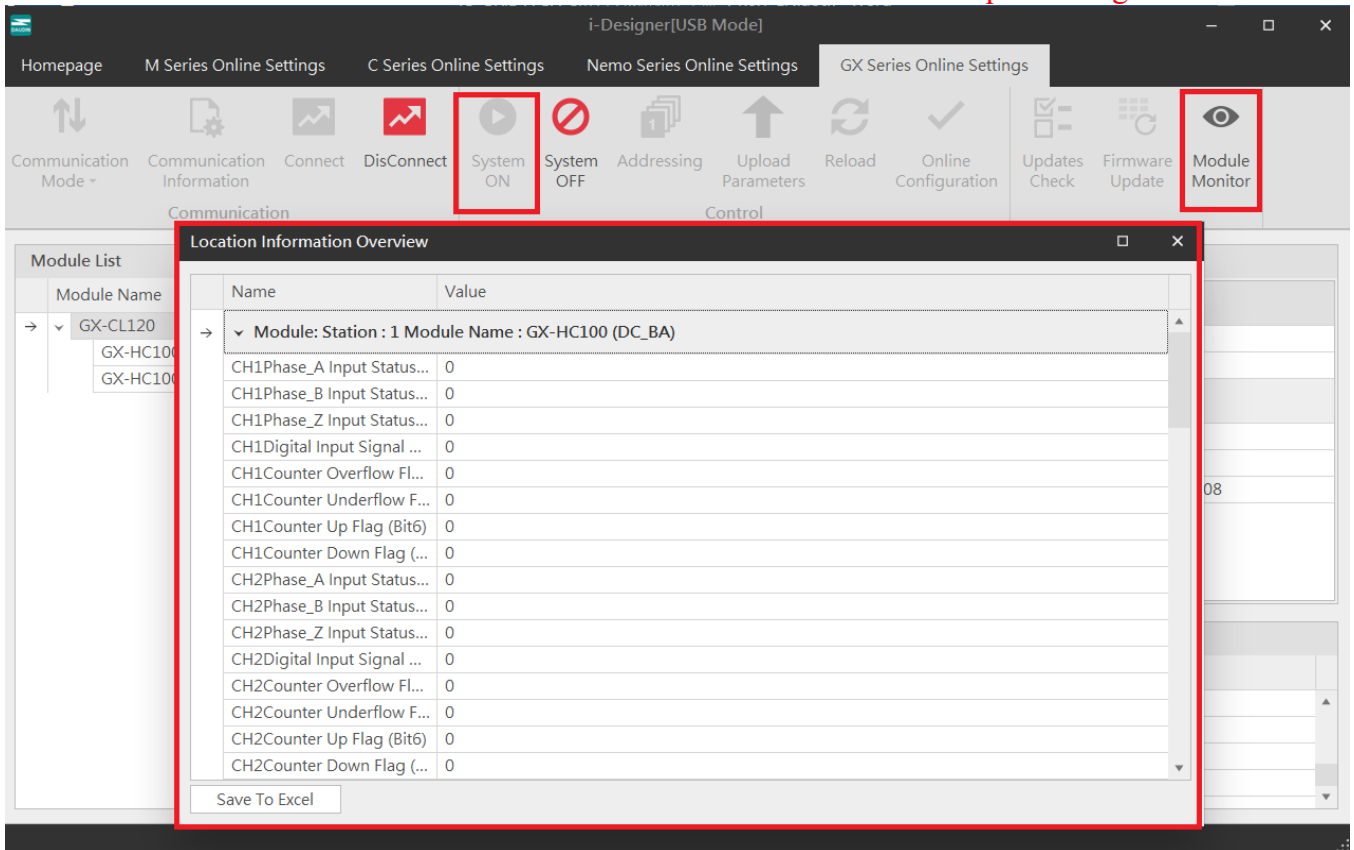

Figure 7.24 Online Adjustment Screen

The system will detect whether the current module version is the latest and prompt for updates.

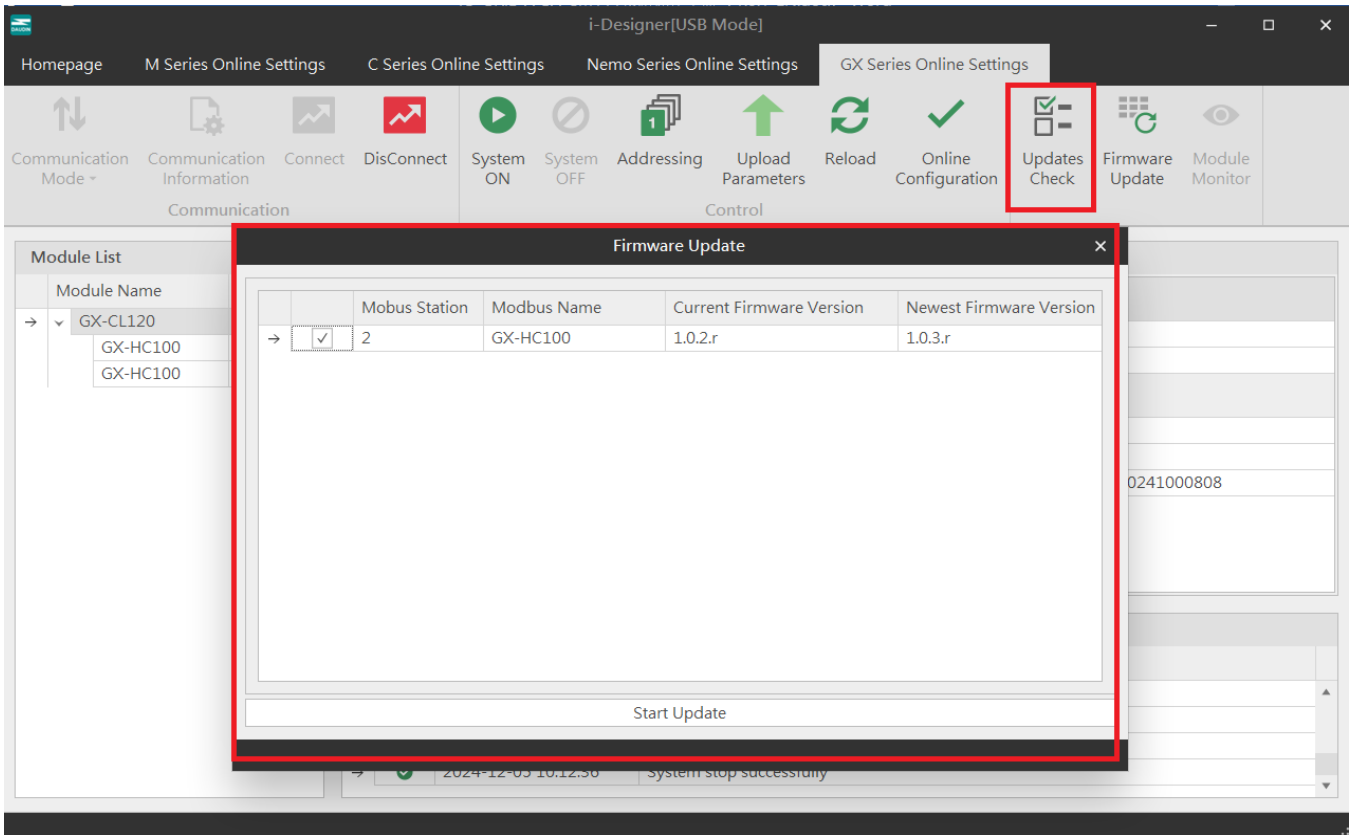

Figure 7.25 Firmware Update Screen

The GX-CL140 will display the Modbus register positions for the configured IO modules.

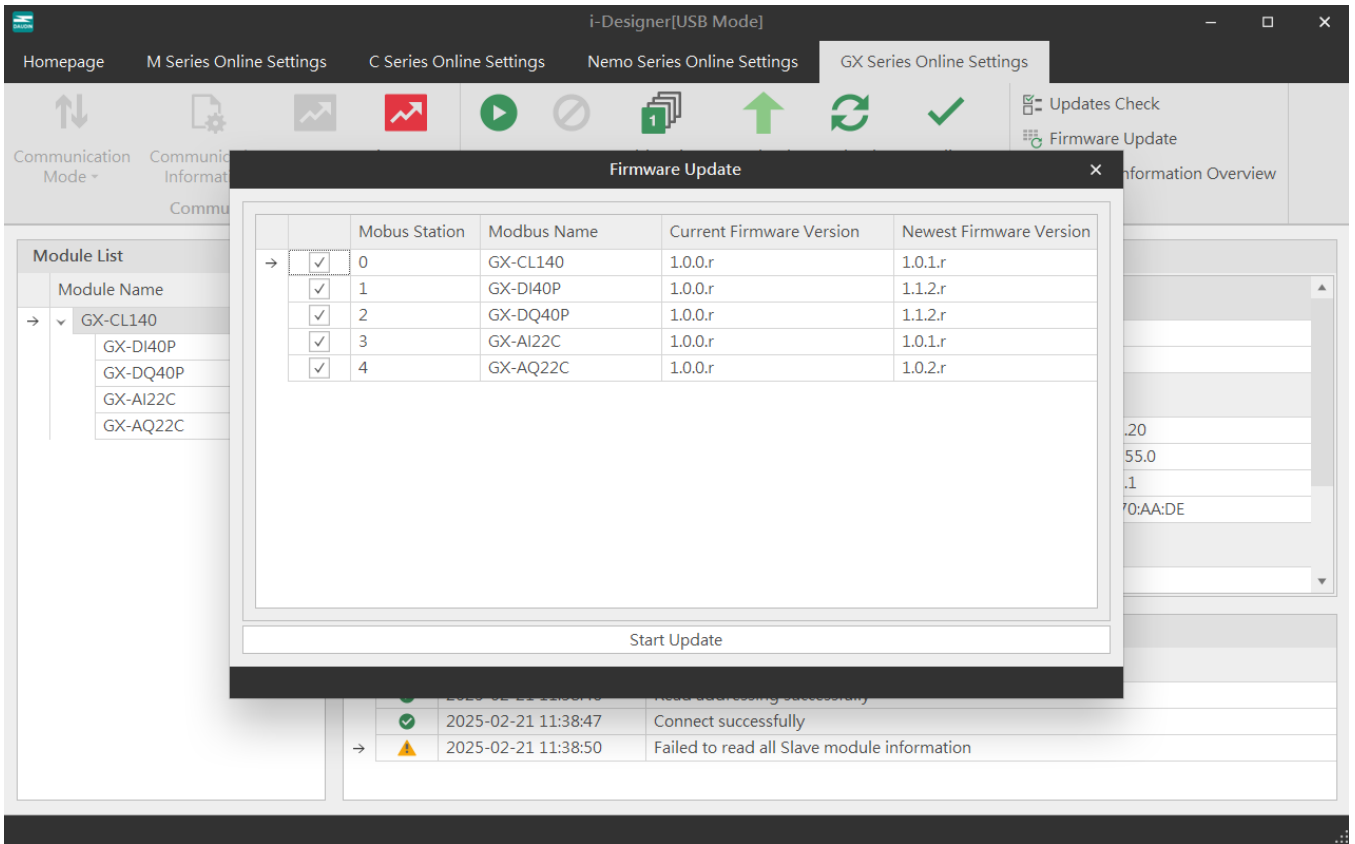

Figure 7.26 Point Information Overview Screen